



**TOOLS WITH THE
POWER TO PERFORM**

www.triumphtwistdrill.com • 800/942/1501 • Chisholm, MN USA

GLOBAL BRANDS



**NORTHLAND DRILL
IMPORTED**



Exclusively Sold in Mexico

T
TRIUMPH[®]
TWIST DRILL
A Division of Minnesota Twist Drill



THUNDERBIT[®]

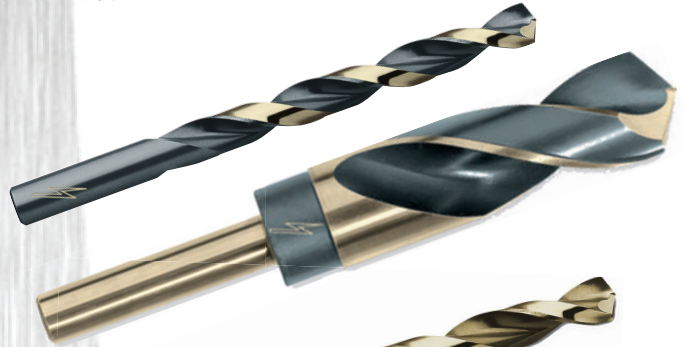

THUNDERBIT[®]
COBALT

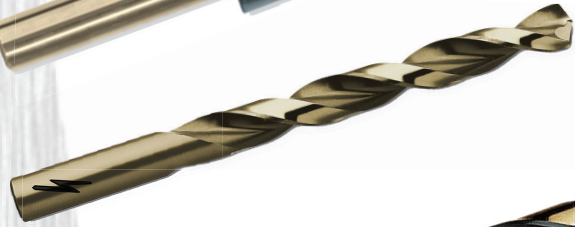

MRO[®]
PLUS



ALIGNMENT
REAMER[®]

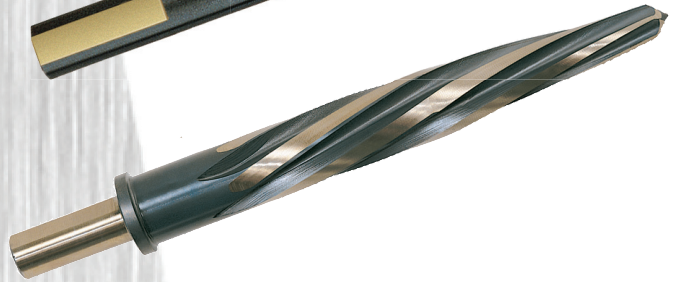

TriNADO[®]



THUNDERTAP[®]



TOOLS WITH
THE POWER[®]
TO PERFORM



Drills

Jobber									Mechanic's Length	Screw Machine		
THUNDERBIT®	THUNDERBIT®	THUNDERBIT® COBALT	MRO						THUNDERBIT®			
Heavy-Duty 135° Split Point, HSS	Heavy-Duty 135° Split Point, HSS	Heavy-Duty 135° Split Point, Cobalt, HSS	Heavy-Duty 135° Split Point, HSS	Heavy-Duty 135° Split Point, HSS	General Purpose, 118° Point, HSS	General Purpose, 118° Point, HSS	Heavy-Duty, 135° Split Point, Cobalt	Left Hand, General Purpose, 118° Pt. HSS	Heavy-Duty 3-Flat Shank 135° Split Point, HSS	Heavy-Duty 135° Split Point, HSS	Heavy-Duty 135° Split Point, HSS	Heavy-Duty 135° Split Point, Cobalt
9-11	13	12	14-15	17-18	19-20	21-23	24-25	26	16	28	27	28
T1HD, BP1HD, T2HD, T3HD, MM1HD	T1HDG	T1HDC	T101D, T102D, T103D	T1D, T2D, T3D	T1B, BP1B, T2B, T3B	T1, BP1, T2, T3, MM1	T1C, BP1C, T2C, T3C	T1L	T1M, BP1M, T8M	T4HD	T4, T5	T4C

Page #
Style

Extra Length Drills			
6" Aircraft Extension 135° Split Point HSS	12" Aircraft Extension 135° Split Point HSS	12" General Purpose 118°, HSS	18" General Purpose 118°, HSS
29	30	30	30
T6HH, BP6HH, T6WW	T12HH, BP12HH, T12WW	T1290	T1813

Silver & Deming			
THUNDERBIT®			
1/2" Shank, 118° Split Point HSS	3-Flat, 1/2" Shank 118° HSS	1/2" Shank, 118° HSS	1/2" Shank 118° Split Point Cobalt
31	31	32	33
T9FHD	T9F	T9	T9C

Reduced Shank Drills			
THUNDERBIT®			
Heavy-Duty, 3/8" Shank 135° Split Point HSS	General Purpose, 1/4" Shank 118° HSS	General Purpose, 3/8" Shank 118° HSS	General Purpose, 1/4" Shank 118° Split Point, HSS
33	34	34	34
T8HD, BP8HD	BP7	T8, BP8	BP10

Page #
Style

Drill Packaging Options Pages 50-51



Drill Packaging Quantities

Tubes	Bulk Master Pack
1, 2, 6, 12	25, 72, 144, 288

Special Purpose Tools

Special Purpose				Reamers		Solid Carbide Burs	Annular Cutters	Annular Cutter Machines
Hole Saw, Pilot Drill, 118° Split, HSS	1/4" Hex Shank, 135° Split, HSS	Body Drill, Double End, 135° Split, HSS	Quick Change Adaptor	Alignment Reamer, HSS	Center Reamer, Countersink, 82°, HSS	Standard, Miniature	Cobalt	Cutter Capacity 1-3/8", Drill Capacity 1/2", Height 15", Weight 28 lbs
38	40	39	39	38	40	35-36	37	Cutter Capacity 2", Drill Capacity 3/4", Height 15.5", Weight 40 lbs
PD3F	HEXT4	TSM8	TQCCI	TCR	T401	SA-SN	TAC	Cutter Capacity 4", Drill Capacity 1-1/2", Height 21", Weight 57 lbs
								37
								ANNULAR CUTTER MACHINE

Taps

HSS Taps		
THU/DERTAP®	THU/DERTAP®	THU/DERTAP®
Straight Flute Hand Tap	Spiral Point Tap	Taper Pipe Tap
Page #	43-44	45-46
Style	T61HD, BP61HD, T62HD, BP62HD	T63HD, BP63HD, T64HD, BP64HD
		T65HD

Tap Packaging Options





Page 52





Tap Packaging Quantities



HSS Taps	
Tubes: 1, 5	Tubes: 1, 5
Snap Pack: 3, 6, 12	





Drills, Special Purpose, Taps/Dies





Jobber			
			
Heavy-Duty 135° Split Point, Black/Gold Oxide, HSS	Heavy-Duty 135° Split Point, TiN Coated, HSS	General Purpose, 118° Point, HSS	Heavy-Duty 135° Split Point, Cobalt, HSS
Page # 54	Page # 55	Page # 53	Page # 56
Style 806-807	Style 803	Style 801-800	Style 804-805
Pkg: Tube	Pkg: Tube	Pkg: Tube	Pkg: Tube

Screw Machine

Heavy-Duty 135° Split Point, HSS
Page # 57
Style 808-809
Pkg: Tube

Silver & Deming

1/2" Shank, 3-Flat 135° Split Point HSS
Page # 58
Style 810
Pkg: Tube

Extra Length Drills	
	
6" Aircraft Extension 135° Split Point HSS	12" Aircraft Extension 135° Split Point HSS
Page # 59	Page # 59
Style 8256	Style 82512
Pkg: Tube	Pkg: Tube

Special Purpose				
				
Body Drill, Double End, 135° Split Point, HSS	Screw Extractor	Flat Wood-boring Bit	Masonry, Carbide- Tipped, 118° Point, Regular/High Helix, Zinc Coated, Sandblasted Finish, Black Finish	Glass & Tile Drill
Page # 59	Page # 64	Page # 64	Page # 64	Page # 64
Style 831	Style 841	Style 840	Style 850, 855	Style 860
Pkg: Tube	Pkg: Tube	Pkg: Tube	Pkg: Tube	Pkg: Tube

Carbon Steel Taps & Dies			
			
Straight Flute Hand Tap, Taper, Bottoming, Plug, Metric	Taper Pipe Tap	Hex Die	Die Stock
Page # 61-62	Page # 62	Page # 63	Page # 63
Style 833 T,B,P 834MP, Pkg: Env.	Style 834NPT Pkg: Envelope	Style 834H-835H 835RD Pkg: Tube	Style 835DS Pkg: Tube

Tap Wrench

Tap Wrench, Straight-Handle T-Handle
Page # 64
Style 835SHW, THW Pkg: Tube

Drill/Special Purpose Packaging Options (Page 66)

Tubes	Indexes
	

Drill Packaging Quantities

Tubes
1, 2, 6, 12

Tap Packaging Options (Page 67)

Tubes	Envelopes	Molded/Plastic Cases
		

Tap Packaging Quantities

Tubes	Envelopes
1, 5, 6, 12	1, 5



Use this chart to help you find the best drill for your job

Simply choose your material and then the corresponding tool



Works Best in This Material	ThunderBit® Black and Bronze	ThunderBit® Cobalt HSS	TriNADO® Black & Bronze	ThunderBit® TiN	Heavy-Duty Black Oxide	Heavy-Duty Cobalt Bronze Oxide	General Purpose Bright	General Purpose Black Oxide	MRO Black & Bronze
Aluminum/Aluminum Alloys; Bronze, Soft and Medium				✓			✓		
Iron, Cast	✓	✓	✓	✓	✓	✓		✓	✓
Steel, Low and Medium Carbon	✓	✓	✓	✓	✓	✓		✓	✓
Steel, High Alloy	✓	✓	✓	✓	✓	✓			✓
Steel, Stainless and PH	✓	✓	✓	✓		✓		✓	✓
Tough, Medium and High-Tensile Strength Alloys	✓	✓	✓	✓	✓	✓			✓
Wood and Plastic				✓			✓		
Point:	135° Split	135° Split	135° Split	135° Split	135° Split	135° Split	118°	118°	135° Split
Page #	9-11	12	16	13	17-20	24-25	21-23	19-20	14-15

Drill Troubleshooting Guide

Trouble	Possible Causes	Corrections
Drill Breaks	Spring or back lash in press or work Too little lip relief Speed too low in proportion to the feed Dull drill Possible chip congestion	Test press and work for rigidity and alignment Regrind properly Increase or decrease speed Sharpen drill Peck drill
Outer Corner Breakdown	Uneven hardness in work material Too much speed Improper cutting compound	Reduce speed Reduce speed Use proper cutting compound
Drill Breaks in Brass or Wood	Chips clog up flutes	Increase speed. Use drills designed for these materials
Cutting Lips Chipped	Too much feed Too much lip relief	Reduce feed Regrind properly
Cracking or Checking in Cutting Edges	Heated and cooled too quickly Too much feed	Warm slowly before using. Do not throw cold water on hot drill while grinding or drilling Reduce feed
Hole too Large	Unequal angle or length of the cutting edges or both Loose spindle	Regrind properly Test spindle for rigidity
Only One Lip Cutting	Unequal length or angle of cutting lips, or both	Regrind drill properly
Drill Splits up Center	Too little lip relief Too much feed	Regrind with proper relief Reduce feed
Rough Hole	Dull or improperly ground drill Lack of lubricant or wrong lubricant Improper set-up Too much feed	Regrind properly Lubricate or change lubricant Check set-up Reduce feed

How to Drill Effectively

Successful Drilling Involves 3 Elements:

- Forming a chip
- Accommodating a chip
- Evacuating a chip

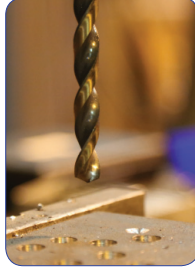

Drill Geometry

- Use the shortest drill possible
- Use a split point drill if possible

Split points begin removing material on contact and drill more efficiently

WARNING: Two-flute drills should not be used to enlarge pre-existing holes

High Performance ThunderBit® Drills are Designed and Engineered to Increase Your Productivity and Tool Life

High Performance Coatings	Heavy-Duty Core Construction (ThunderBit®)	(vs)	General Purpose
Black Oxide Bronze Oxide Titanium Nitride Coating (TiN)	<p>24% of Drill Diameter</p> <p>(Heavy-Duty Web Construction)</p>		<p>57% of Drill Diameter</p>
<p>Quick Penetration Split Point</p> <p>135° Split Point</p>			

Unique spiral flute design improves chip ejection and coolant flow to the point. The heavy-duty core guarantees increased strength and reduced breakage.

**TOOLS WITH
THE POWER®
TO PERFORM**



Corresponding Drill Sets appear on each page, and also in the Drill Set Section starting on Page 48.

• Jobber Drill

• Broca, serie corta

• Foret court



THUNDERBIT[®]

Point: 135° Split Point
 Material: Premium Grade High Speed Steel
 Coating/Finish: Black and Bronze Oxide
 Other: Heavy-Duty Construction

DRILLS

T1HD

Packaging: Tube

Size	Decimal Equivalent	Flute Length	Overall Length	Stock#	Pkg Qty
1/16	.0625	7/8	1-7/8	012504	12
5/64	.0781	1	2	012505	12
3/32	.0938	1-1/4	2-1/4	012506	12
7/64	.1094	1-1/2	2-5/8	012507	12
1/8	.1250	1-5/8	2-3/4	012508	12
9/64	.1406	1-3/4	2-7/8	012509	12
5/32	.1562	2	3-1/8	012510	12
11/64	.1719	2-1/8	3-1/4	012511	12
3/16	.1875	2-5/16	3-1/2	012512	12
13/64	.2031	2-7/16	3-5/8	012513	12
7/32	.2188	2-1/2	3-3/4	012514	12
15/64	.2344	2-5/8	3-7/8	012515	12
1/4	.2500	2-3/4	4	012516	12
17/64	.2656	2-7/8	4-1/8	012517	12
9/32	.2812	2-15/16	4-1/4	012518	12
19/64	.2969	3-1/16	4-3/8	012519	12
5/16	.30125	3-3/16	4-1/2	012520	6
21/64	.3281	3-5/16	4-5/8	012521	6
11/32	.3438	3-7/16	4-3/4	012522	6
23/64	.3594	3-1/2	4-7/8	012523	6
3/8	.3750	3-5/8	5	012524	6
25/64	.3906	3-3/4	5-1/8	012525	6
13/32	.4062	3-7/8	5-1/4	012526	6
27/64	.4219	3-15/16	5-3/8	012527	6
7/16	.4375	4-1/16	5-1/2	012528	6
29/64	.4531	4-3/16	5-5/8	012529	6
15/32	.4688	4-5/16	5-3/4	012530	6
31/64	.4844	4-3/8	5-7/8	012531	6
1/2	.5000	4-1/2	6	012532	6

T1HD

Packaging: Bulk Master Pack

Size	Decimal Equivalent	Flute Length	Overall Length	Stock#	Pkg Qty
1/16	.0625	7/8	1-7/8	012504.20	288
5/64	.0781	1	2	012505.20	288
3/32	.0938	1-1/4	2-1/4	012506.20	288
7/64	.1094	1-1/2	2-5/8	012507.20	288
1/8	.1250	1-5/8	2-3/4	012508.20	288
9/64	.1406	1-3/4	2-7/8	012509.20	288
5/32	.1562	2	3-1/8	012510.20	288
11/64	.1719	2-1/8	3-1/4	012511.20	288
3/16	.1875	2-5/16	3-1/2	012512.20	288
13/64	.2031	2-7/16	3-5/8	012513.20	288
7/32	.2188	2-1/2	3-3/4	012514.20	288
15/64	.2344	2-5/8	3-7/8	012515.20	288
1/4	.2500	2-3/4	4	012516.20	288
17/64	.2656	2-7/8	4-1/8	012517.20	144
9/32	.2812	2-15/16	4-1/4	012518.20	144
19/64	.2969	3-1/16	4-3/8	012519.20	144
5/16	.30125	3-3/16	4-1/2	012520.20	144
21/64	.3281	3-5/16	4-5/8	012521.20	144
11/32	.3438	3-7/16	4-3/4	012522.20	144
23/64	.3594	3-1/2	4-7/8	012523.20	144
3/8	.3750	3-5/8	5	012524.20	144
25/64	.3906	3-3/4	5-1/8	012525.20	144
13/32	.4062	3-7/8	5-1/4	012526.20	144
27/64	.4219	3-15/16	5-3/8	012527.20	144
7/16	.4375	4-1/16	5-1/2	012528.20	144
29/64	.4531	4-3/16	5-5/8	012529.20	144
15/32	.4688	4-5/16	5-3/4	012530.20	144
31/64	.4844	4-3/8	5-7/8	012531.20	144
1/2	.5000	4-1/2	6	012532.20	144



Corresponding Sets

Style	Description	# of Pieces	Size Range	Stock#
SAD13HD	Select-A-Drill	13 Piece	1/16"-1/4" by 64ths	090495
SAD21HD	Select-A-Drill	21 Piece	1/16"-3/8" by 64ths	090496
T19HD	Metal Index	13 Piece	1/16"-1/4" by 64ths	099858
T18HD	Metal Index	15 Piece	1/16"-1/2" by 32nds	099857
T180HD	Metal Index	21 Piece	1/16"-3/8" by 64ths	099861
T17HDDC	Clip-On Index	29 Piece	1/16"-1/2" by 64ths	099855
T17HD	Metal Index	29 Piece	1/16"-1/2" by 64ths	099856
T22HD	Metal Index	60 Piece	#1-#60	099859
T25HD	Metal Index	26 Piece	A - Z	099860
T123HD	Metal Index	115 Piece	1/16"-1/2" by 64ths, #1-#60, A-Z	099862
T80HD	Display		1/16"-1/2" by 64ths	099995

Works Best in This Material	ThunderBit
Aluminum/Aluminum Alloys; Bronze, Soft and Medium	
Iron, Cast	✓
Steel, Low and Medium Carbon	✓
Steel, High Alloy	✓
Steel, Stainless and PH	✓
Tough, Medium and High-Tensile Strength Alloys	✓
Wood and Plastic	



• Jobber Drill

• Broca, serie corta

• Foret court



Point: 135° Split Point
 Material: Premium Grade High Speed Steel
 Coating/Finish: Black and Bronze Oxide
 Other: Heavy-Duty Construction

BP1HD

Packaging: Tube

Size	Decimal Equivalent	Flute Length	Overall Length	Stock#	Pkg Qty
1/16	.0625	7/8	1-7/8	014004	1
5/64	.0781	1	2	014005	1
3/32	.0938	1-1/4	2-1/4	014006	1
7/64	.1094	1-1/2	2-5/8	014007	1
1/8	.1250	1-5/8	2-3/4	014008	1
9/64	.1406	1-3/4	2-7/8	014009	1
5/32	.1562	2	3-1/8	014010	1
11/64	.1719	2-1/8	3-1/4	014011	1
3/16	.1875	2-5/16	3-1/2	014012	1
13/64	.2031	2-7/16	3-5/8	014013	1
7/32	.2188	2-1/2	3-3/4	014014	1
15/64	.2344	2-5/8	3-7/8	014015	1
1/4	.2500	2-3/4	4	014016	1
17/64	.2656	2-7/8	4-1/8	014017	1
9/32	.2812	2-15/16	4-1/4	014018	1
19/64	.2969	3-1/16	4-3/8	014019	1
5/16	.3125	3-3/16	4-1/2	014020	1
21/64	.3281	3-5/16	4-5/8	014021	1
11/32	.3438	3-7/16	4-3/4	014022	1
23/64	.3594	3-1/2	4-7/8	014023	1
3/8	.3750	3-5/8	5	014024	1
25/64	.3906	3-3/4	5-1/8	014025	1
13/32	.4062	3-7/8	5-1/4	014026	1
27/64	.4219	3-15/16	5-3/8	014027	1
7/16	.4375	4-1/16	5-1/2	014028	1
29/64	.4531	4-3/16	5-5/8	014029	1
15/32	.4688	4-5/16	5-3/4	014030	1
31/64	.4844	4-3/8	5-7/8	014031	1
1/2	.5000	4-1/2	6	014032	1

T2HD

Packaging: Tube

Size	Decimal Equivalent	Flute Length	Overall Length	Stock#	Pkg Qty
44	.0860	1-1/8	2-1/8	012644	12
43	.0890	1-1/4	2-1/4	012643	12
42	.0935	1-1/4	2-1/4	012642	12
41	.0960	1-3/8	2-3/8	012641	12
40	.0980	1-3/8	2-3/8	012640	12
39	.0995	1-3/8	2-3/8	012639	12
38	.1015	1-7/16	2-1/2	012638	12
37	.1040	1-7/16	2-1/2	012637	12
36	.1065	1-7/16	2-1/2	012636	12
35	.1100	1-1/2	2-5/8	012635	12
34	.1110	1-1/2	2-5/8	012634	12
33	.1130	1-1/2	2-5/8	012633	12
32	.1160	1-5/8	2-3/4	012632	12
31	.1200	1-5/8	2-3/4	012631	12
30	.1285	1-5/8	2-3/4	012630	12
29	.1360	1-3/4	2-7/8	012629	12
28	.1405	1-3/4	2-7/8	012628	12
27	.1440	1-7/8	3	012627	12
26	.1470	1-7/8	3	012626	12
25	.1495	1-7/8	3	012625	12
24	.1520	2	3-1/8	012624	12
23	.1540	2	3-1/8	012623	12
22	.1570	2	3-1/8	012622	12
21	.1590	2-1/8	3-1/4	012621	12
20	.1610	2-1/8	3-1/4	012620	12
19	.1660	2-1/8	3-1/4	012619	12
18	.1695	2-1/8	3-1/4	012618	12
17	.1730	2-3/16	3-3/8	012617	12
16	.1770	2-3/16	3-3/8	012616	12
15	.1800	2-3/16	3-3/8	012615	12
14	.1820	2-3/16	3-3/8	012614	12
13	.1850	2-5/16	3-1/2	012613	12
12	.1890	2-5/16	3-1/2	012612	12
11	.1910	2-5/16	3-1/2	012611	12
10	.1935	2-7/16	3-5/8	012610	12
9	.1960	2-7/16	3-5/8	012609	12
8	.1990	2-7/16	3-5/8	012608	12
7	.2010	2-7/16	3-5/8	012607	12
6	.2040	2-1/2	3-3/4	012606	12
5	.2055	2-1/2	3-3/4	012605	12
4	.2090	2-1/2	3-3/4	012604	12
3	.2130	2-1/2	3-3/4	012603	12
2	.2210	2-5/8	3-7/8	012602	12
1	.2280	2-5/8	3-7/8	012601	12

T2HD

Packaging: Tube

Size	Decimal Equivalent	Flute Length	Overall Length	Stock#	Pkg Qty
60	.0400	11/16	1-5/8	012660	12
59	.0410	11/16	1-5/8	012659	12
58	.0420	11/16	1-5/8	012658	12
57	.0430	3/4	1-3/4	012657	12
56	.0465	3/4	1-3/4	012656	12
55	.0520	7/8	1-7/8	012655	12
54	.0550	7/8	1-7/8	012654	12
53	.0595	7/8	1-7/8	012653	12
52	.0635	7/8	1-7/8	012652	12
51	.0670	1	2	012651	12
50	.0700	1	2	012650	12
49	.0730	1	2	012649	12
48	.0760	1	2	012648	12
47	.0785	1	2	012647	12
46	.0810	1-1/8	2-1/8	012646	12
45	.0820	1-1/8	2-1/8	012645	12



Find the Best Drill for Your Job . . . Page 7

• Jobber Drill

• Broca, serie corta

• Foret court

THUNDERBIT®



Point: 135° Split Point
 Material: Premium Grade High Speed Steel
 Coating/Finish: Black and Bronze Oxide
 Other: Heavy-Duty Construction



Point: 135° Split Point
 Material: High Speed Steel
 Coating/Finish: Black and Bronze Oxide
 Other: Heavy-Duty Construction

T3HD

Packaging: Tube

Size	Decimal Equivalent	Flute Length	Overall Length	Stock#	Pkg Qty
A	.2340	2-5/8	3-7/8	012701	12
B	.2380	2-3/4	4	012702	12
C	.2420	2-3/4	4	012703	12
D	.2460	2-3/4	4	012704	12
E	.2500	2-3/4	4	012705	12
F	.2570	2-7/8	4-1/8	012706	12
G	.2610	2-7/8	4-1/8	012707	12
H	.2660	2-7/8	4-1/8	012708	12
I	.2720	2-7/8	4-1/8	012709	12
J	.2770	2-7/8	4-1/8	012710	12
K	.2810	2-15/16	4-1/4	012711	12
L	.2900	2-15/16	4-1/4	012712	12
M	.2950	3-1/16	4-3/8	012713	12
N	.3020	3-1/16	4-3/8	012714	12
O	.3160	3-3/16	4-1/2	012715	6
P	.3230	3-5/16	4-5/8	012716	6
Q	.3320	3-7/16	4-3/4	012717	6
R	.3390	3-7/16	4-3/4	012718	6
S	.3480	3-1/2	4-7/8	012719	6
T	.3580	3-1/2	4-7/8	012720	6
U	.3680	3-5/8	5	012721	6
V	.3770	3-5/8	5	012722	6
W	.3860	3-3/4	5-1/8	012723	6
X	.3970	3-3/4	5-1/8	012724	6
Y	.4040	3-7/8	5-1/4	012725	6
Z	.4130	3-7/8	5-1/4	012726	6

MM1HD, Metric

Packaging: Tube

Size	Decimal Equivalent	Flute Length	Overall Length	Stock#	Pkg Qty
1.00	.0394	17	41	014310	12
1.50	.0591	22	48	014315	12
2.00	.0787	25	51	014320	12
2.50	.0984	35	60	014325	12
3.00	.1181	41	70	014330	12
3.50	.1378	44	73	014335	12
4.00	.1575	54	83	014340	12
4.50	.1772	56	86	014345	12
5.00	.1969	62	92	014350	12
5.50	.2165	64	95	014355	12
6.00	.2362	70	102	014360	12
6.50	.2559	73	105	014365	12
7.00	.2756	73	105	014370	6
7.50	.2953	78	111	014375	6
8.00	.3150	81	114	014380	6
8.50	.3346	87	121	014385	6
9.00	.3543	89	124	014390	6
9.50	.3740	92	127	014395	6
10.00	.3937	95	130	014400	6
10.50	.4134	98	133	014405	6
11.00	.4331	103	140	014410	6
11.50	.4528	106	143	014415	6
12.00	.4724	111	149	014420	6
12.50	.4921	114	152	014425	6
13.00	.5118	114	152	014430	1

Works Best in This Material

Works Best in This Material	ThunderBit
Aluminum/Aluminum Alloys; Bronze, Soft and Medium	
Iron, Cast	✓
Steel, Low and Medium Carbon	✓
Steel, High Alloy	✓
Steel, Stainless and PH	✓
Tough, Medium and High-Tensile Strength Alloys	✓
Wood and Plastic	



Corresponding Sets

Style	Description	# of Pieces	Size Range	Stock#
MM19HD	Metal Index	19 Piece	1mm-10mm x .5	099866
MM25HD	Metal Index	25 Piece	1mm-12mm x .5	099867

• Jobber Drill

• Broca, serie corta

• Foret court



Point: 135° Split Point
 Material: Cobalt, High Speed Steel
 Coating/Finish: Bronze Oxide
 Other: Heavy-Duty Construction

T1HDC

Packaging: Tube



Corresponding Set

Size	Decimal Equivalent	Flute Length	Overall Length	Stock#	Pkg Qty
1/16	.0625	7/8	1-7/8	013504	12
5/64	.0781	1	2	013505	12
3/32	.0938	1-1/4	2-1/4	013506	12
7/64	.1094	1-1/2	2-5/8	013507	12
1/8	.1250	1-5/8	2-3/4	013508	12
9/64	.1406	1-3/4	2-7/8	013509	12
5/32	.1562	2	3-1/8	013510	12
11/64	.1719	2-1/8	3-1/4	013511	12
3/16	.1875	2-5/16	3-1/2	013512	12
13/64	.2031	2-7/16	3-5/8	013513	12
7/32	.2188	2-1/2	3-3/4	013514	12
15/64	.2344	2-5/8	3-7/8	013515	12
1/4	.2500	2-3/4	4	013516	12
17/64	.2656	2-7/8	4-1/8	013517	12
9/32	.2812	2-15/16	4-1/4	013518	12
19/64	.2969	3-1/16	4-3/8	013519	12
5/16	.3125	3-3/16	4-1/2	013520	6
21/64	.3281	3-5/16	4-5/8	013521	6
11/32	.3438	3-7/16	4-3/4	013522	6
23/64	.3594	3-1/2	4-7/8	013523	6
3/8	.3750	3-5/8	5	013524	6
25/64	.3906	3-3/4	5-1/8	013525	6
13/32	.4062	3-7/8	5-1/4	013526	6
27/64	.4219	3-15/16	5-3/8	013527	6
7/16	.4375	4-1/16	5-1/2	013528	6
29/64	.4531	4-3/16	5-5/8	013529	6
15/32	.4688	4-5/16	5-3/4	013530	6
31/64	.4844	4-3/8	5-7/8	013531	6
1/2	.5000	4-1/2	6	013532	6

Style	Description	# of Pieces	Size Range	Stock#
T19HDC	Metal Index	13 Piece	1/16"-1/4" by 64ths	099813
T18HDC	Metal Index	15 Piece	1/16"-1/2" by 32nds	099816
T180HDC	Metal Index	21 Piece	1/16"-3/8" by 64ths	099819
T17HDC	Metal Index	29 Piece	1/16"-1/2" by 64ths	099821
T17HDCDC	Clip On Index	29 Piece	1/16"-1/2" by 64ths	099854

Works Best in This Material	Heavy-Duty Cobalt Bronze Oxide
Iron, Cast	✓
Steel, Low and Medium Carbon	✓
Steel, High Alloy	✓
Steel, Stainless and PH	✓
Tough, Medium and High-Tensile Strength Alloys	✓



Find the Best Drill for Your Job . . . Page 7

• Jobber Drill

• Broca, serie corta

• Foret court

DRILLS



Point: 135° Split Point
 Material: Premium Grade High Speed Steel
 Coating/Finish: TiN Coating
 Other: Heavy-Duty Construction

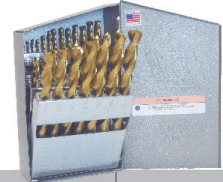

T1HDG

Packaging: Tube

Corresponding Set

Size	Decimal Equivalent	Flute Length	Overall Length	Stock#	Pkg Qty
1/16	.0625	7/8	1-7/8	012804	12
5/64	.0781	1	2	012805	12
3/32	.0938	1-1/4	2-1/4	012806	12
7/64	.1094	1-1/2	2-5/8	012807	12
1/8	.1250	1-5/8	2-3/4	012808	12
9/64	.1406	1-3/4	2-7/8	012809	12
5/32	.1562	2	3-1/8	012810	12
11/64	.1719	2-1/8	3-1/4	012811	12
3/16	.1875	2-5/16	3-1/2	012812	12
13/64	.2031	2-7/16	3-5/8	012813	12
7/32	.2188	2-1/2	3-3/4	012814	12
15/64	.2344	2-5/8	3-7/8	012815	12
1/4	.2500	2-3/4	4	012816	12
17/64	.2656	2-7/8	4-1/8	012817	12
9/32	.2812	2-15/16	4-1/4	012818	12
19/64	.2969	3-1/16	4-3/8	012819	12
5/16	.3125	3-3/16	4-1/2	012820	6
21/64	.3281	3-5/16	4-5/8	012821	6
11/32	.3438	3-7/16	4-3/4	012822	6
23/64	.3594	3-1/2	4-7/8	012823	6
3/8	.3750	3-5/8	5	012824	6
25/64	.3906	3-3/4	5-1/8	012825	6
13/32	.4062	3-7/8	5-1/4	012826	6
27/64	.4219	3-15/16	5-3/8	012827	6
7/16	.4375	4-1/16	5-1/2	012828	6
29/64	.4531	4-3/16	5-5/8	012829	6
15/32	.4688	4-5/16	5-3/4	012830	6
31/64	.4844	4-3/8	5-7/8	012831	6
1/2	.5000	4-1/2	6	012832	6

Style	Description	# of Pieces	Size Range	Stock#
T17HDG	Metal Index	29 Piece	1/16"-1/2" by 64ths, TiN Coated	093700



Find the Best Drill for Your Job . . . Page 7

• Jobber Drill

• Broca, serie corta

• Foret court



Point: 135° Split Point
Material: Premium Grade High Speed Steel
Coating/Finish: Black and Gold
Other: Heavy-Duty Construction
Fractional, Wire, Letter sizes - 3 Flats on Shank



T101D

Packaging: Tube

Size	Decimal Equivalent	Flute Length	Overall Length	Stock#	Pkg Qty
1/16	.0625	7/8	1-7/8	022704	12
5/64	.0781	1	2	022705	12
3/32	.0938	1-1/4	2-1/4	022706	12
7/64	.1094	1-1/2	2-5/8	022707	12
1/8	.1250	1-5/8	2-3/4	022708	12
9/64	.1406	1-3/4	2-7/8	022709	12
5/32	.1562	2	3-1/8	022710	12
11/64	.1719	2-1/8	3-1/4	022711	12

3-Flats on Shank

Size	Decimal Equivalent	Flute Length	Overall Length	Stock#	Pkg Qty
3/16	.1875	2-5/16	3-1/2	022712	12
13/64	.2031	2-7/16	3-5/8	022713	12
7/32	.2188	2-1/2	3-3/4	022714	12
15/64	.2344	2-5/8	3-7/8	022715	12
1/4	.2500	2-3/4	4	022716	12
17/64	.2656	2-7/8	4-1/8	022717	12
9/32	.2812	2-15/16	4-1/4	022718	12
19/64	.2969	3-1/16	4-3/8	022719	12
5/16	.3125	3-3/16	4-1/2	022720	6
21/64	.3281	3-5/16	4-5/8	022721	6
11/32	.3438	3-7/16	4-3/4	022722	6
23/64	.3594	3-1/2	4-7/8	022723	6
3/8	.3750	3-5/8	5	022724	6
25/64	.3906	3-3/4	5-1/8	022725	6
13/32	.4062	3-7/8	5-1/4	022726	6
27/64	.4219	3-15/16	5-3/8	022727	6
7/16	.4375	4-1/16	5-1/2	022728	6
29/64	.4531	4-3/16	5-5/8	022729	6
15/32	.4688	4-5/16	5-3/4	022730	6
31/64	.4844	4-3/8	5-7/8	022731	6
1/2	.5000	4-1/2	6	022732	6



T102D, Wire

Packaging: Tube

Size	Decimal Equivalent	Flute Length	Overall Length	Stock#	Pkg Qty
60*	.0400	11/16	1-5/8	024760	12
59*	.0410	11/16	1-5/8	024759	12
58*	.0420	11/16	1-5/8	024758	12
57*	.0430	3/4	1-3/4	024757	12
56*	.0465	3/4	1-3/4	024756	12
55*	.0520	7/8	1-7/8	024755	12
54*	.0550	7/8	1-7/8	024754	12
53*	.0595	7/8	1-7/8	024753	12
52	.0635	7/8	1-7/8	024752	12
51	.0670	1	2	024751	12
50	.0700	1	2	024750	12
49	.0730	1	2	024749	12
48	.0760	1	2	024748	12
47	.0785	1	2	024747	12
46	.0810	1-1/8	2-1/8	024746	12
45	.0820	1-1/8	2-1/8	024745	12
44	.0860	1-1/8	2-1/8	024744	12
43	.0890	1-1/4	2-1/4	024743	12
42	.0935	1-1/4	2-1/4	024742	12
41	.0960	1-3/8	2-3/8	024741	12
40	.0980	1-3/8	2-3/8	024740	12
39	.0995	1-3/8	2-3/8	024739	12
38	.1015	1-7/16	2-1/2	024738	12
37	.1040	1-7/16	2-1/2	024737	12
36	.1065	1-7/16	2-1/2	024736	12
35	.1100	1-1/2	2-5/8	024735	12
34	.1110	1-1/2	2-5/8	024734	12
33	.1130	1-1/2	2-5/8	024733	12
32	.1160	1-5/8	2-3/4	024732	12
31	.1200	1-5/8	2-3/4	024731	12
30	.1285	1-5/8	2-3/4	024730	12
29	.1360	1-3/4	2-7/8	024729	12
28	.1405	1-3/4	2-7/8	024728	12
27	.1440	1-7/8	3	024727	12
26	.1470	1-7/8	3	024726	12
25	.1495	1-7/8	3	024725	12
24	.1520	2	3-1/8	024724	12
23	.1540	2	3-1/8	024723	12
22	.1570	2	3-1/8	024722	12
21	.1590	2-1/8	3-1/4	024721	12
20	.1610	2-1/8	3-1/4	024720	12
19	.1660	2-1/8	3-1/4	024719	12
18	.1695	2-1/8	3-1/4	024718	12
17	.1730	2-3/16	3-3/8	024717	12
16	.1770	2-3/16	3-3/8	024716	12
15	.1800	2-3/16	3-3/8	024715	12
14	.1820	2-3/16	3-3/8	024714	12
13	.1850	2-5/16	3-1/2	024713	12
12	.1890	2-5/16	3-1/2	024712	12
11	.1910	2-5/16	3-1/2	024711	12
10	.1935	2-7/16	3-5/8	024710	12
9	.1960	2-7/16	3-5/8	024709	12
8	.1990	2-7/16	3-5/8	024708	12
7	.2010	2-7/16	3-5/8	024707	12
6	.2040	2-1/2	3-3/4	024706	12
5	.2055	2-1/2	3-3/4	024705	12
4	.2090	2-1/2	3-3/4	024704	12
3	.2130	2-1/2	3-3/4	024703	12
2	.2210	2-5/8	3-7/8	024702	12
1	.2280	2-5/8	3-7/8	024701	12

Works Best in This Material	MRO Black and Bright
Aluminum/Aluminum Alloys; Bronze, Soft and Medium	
Iron, Cast	✓
Steel, Low and Medium Carbon	✓
Steel, High Alloy	✓
Steel, Stainless and PH	✓
Tough, Medium and High-Tensile Strength Alloys	✓

*Not Split Point

#1-12: 3 Flats on Shank

• Jobber Drill

• Broca, serie corta

• Foret court



Point: 135° Split Point
 Material: Premium Grade High Speed Steel
 Coating/Finish: Black and Gold
 Other: Heavy-Duty Construction
 Fractional, Wire, Letter sizes - 3 Flats on Shank



T103D, Letter

Packaging: Tube

Size	Decimal Equivalent	Flute Length	Overall Length	Stock#	Pkg Qty
A	.2340	2-5/8	3-7/8	026701	12
B	.2380	2-3/4	4	026702	12
C	.2420	2-3/4	4	026703	12
D	.2460	2-3/4	4	026704	12
E	.2500	2-3/4	4	026705	12
F	.2570	2-7/8	4-1/8	026706	12
G	.2610	2-7/8	4-1/8	026707	12
H	.2660	2-7/8	4-1/8	026708	12
I	.2720	2-7/8	4-1/8	026709	12
J	.2770	2-7/8	4-1/8	026710	12
K	.2810	2-15/16	4-1/4	026711	12
L	.2900	2-15/16	4-1/4	026712	12
M	.2950	3-1/16	4-3/8	026713	12
N	.3020	3-1/16	4-3/8	026714	12
O	.3160	3-3/16	4-1/2	026715	6
P	.3230	3-5/16	4-5/8	026716	6
Q	.3320	3-7/16	4-3/4	026717	6
R	.3390	3-7/16	4-3/4	026718	6
S	.3480	3-1/2	4-7/8	026719	6
T	.3580	3-1/2	4-7/8	026720	6
U	.3680	3-5/8	5	026721	6
V	.3770	3-5/8	5	026722	6
W	.3860	3-3/4	5-1/8	026723	6
X	.3970	3-3/4	5-1/8	026724	6
Y	.4040	3-7/8	5-1/4	026725	6
Z	.4130	3-7/8	5-1/4	026726	6

All Letter Sizes: 3 Flats on Shank

Works Best in This Material	MRO Black and Bright
Aluminum/Aluminum Alloys; Bronze, Soft and Medium	
Iron, Cast	✓
Steel, Low and Medium Carbon	✓
Steel, High Alloy	✓
Steel, Stainless and PH	✓
Tough, Medium and High-Tensile Strength Alloys	✓

Corresponding Sets

T101D, T102D, T103D

Style	Description	# of Pieces	Size Range	Stock#
T1019D	Metal Index	13	1/16"-1/4" by 64ths	090113
T1018D	Metal Index	15	1/16"-1/2" by 32nds	090115
T10180D	Metal Index	21	1/16"-3/8" by 64ths	090121
T10125D	Metal Index	26	A-Z	099828
T1017D	Metal Index	29	1/16"-1/2" by 64ths	090190
T1017DC	Round Twist Top Drill Caddy	29	1/16"-1/2" by 64ths	090192
T10123D	Metal Index	115	1/16"-1/2" by 64ths, #1-#60, A-Z	090196





• Mechanic's Length Drills

• Broca Corta

• Forets à Longeur Mécanique



Point: 135° Split Point
 Material: Premium Grade High Speed Steel
 Coating/Finish: Black and Bronze Oxide
 Other: Heavy-Duty Construction. Sizes 3/16" and larger have 3 flats on shank

T1M, Straight Shank

Packaging: Tube

Size	Decimal Equivalent	Flute Length	Overall Length	Stock#	Pkg Qty
1/16	.0625	7/8	1-7/8	033304	12
5/64	.0781	1	2	033305	12
3/32	.0938	1-1/4	2-1/4	033306	12
7/64	.1094	1-5/16	2-3/8	033307	12
1/8	.1250	1-7/16	2-1/2	033308	12
9/64	.1406	1-9/16	2-5/8	033309	12
5/32	.1562	1-11/16	2-3/4	033310	12
11/64	.1719	1-13/16	2-7/8	033311	12

3-Flats on Shank

3/16	.1875	1-7/8	3	033312	12
13/64	.2031	1-15/16	3-1/8	033313	12
7/32	.2188	2	3-1/4	033314	12
15/64	.2344	2-1/16	3-3/8	033315	12
1/4	.2500	2	3-1/2	033316	12
17/64	.2656	2-1/8	3-5/8	033317	12
9/32	.2812	2-1/4	3-3/4	033318	12
19/64	.2969	2-3/8	3-7/8	033319	12
5/16	.3125	2-1/2	4	033320	6
21/64	.3281	2-9/16	4-1/16	033321	6
11/32	.3438	2-5/8	4-1/8	033322	6
23/64	.3594	2-11/16	4-3/16	033323	6
3/8	.3750	2-11/16	4-1/4	033324	6
25/64*	.3906	2-3/4	4-5/16	033325	6
13/32*	.4062	2-13/16	4-3/8	033326	6
27/64	.4219	2-7/8	4-7/16	033327	6
7/16	.4375	2-15/16	4-1/2	033328	6
29/64	.4531	3	4-5/8	033329	6
15/32	.4688	3-1/8	4-3/4	033330	6
31/64	.4844	3-1/4	4-7/8	033331	6
1/2	.5000	3-3/8	5	033332	6

*T1M, BP1M - Drill sizes 25/64" and 13/32" will fit a 3/8" chuck without reducing the shank

BP1M, Straight Shank

Packaging: Tube

Size	Decimal Equivalent	Flute Length	Overall Length	Stock#	Pkg Qty
1/16	.0625	7/8	1-7/8	035304	1
5/64	.0781	1	2	035305	1
3/32	.0938	1-1/4	2-1/4	035306	1
7/64	.1094	1-5/16	2-3/8	035307	1
1/8	.1250	1-7/16	2-1/2	035308	1
9/64	.1406	1-9/16	2-5/8	035309	1
5/32	.1562	1-11/16	2-3/4	035310	1
11/64	.1719	1-13/16	2-7/8	035311	1

3-Flats on Shank

3/16	.1875	1-7/8	3	035312	1
13/64	.2031	1-15/16	3-1/8	035313	1
7/32	.2188	2	3-1/4	035314	1
15/64	.2344	2-1/16	3-3/8	035315	1
1/4	.2500	2	3-1/2	035316	1
17/64	.2656	2-1/8	3-5/8	035317	1
9/32	.2812	2-1/4	3-3/4	035318	1
19/64	.2969	2-3/8	3-7/8	035319	1
5/16	.3125	2-1/2	4	035320	1
21/64	.3281	2-9/16	4-1/16	035321	1
11/32	.3438	2-5/8	4-1/8	035322	1
23/64	.3594	2-11/16	4-3/16	035323	1
3/8	.3750	2-11/16	4-1/4	035324	1
25/64*	.3906	2-3/4	4-5/16	035325	1
13/32*	.4062	2-13/16	4-3/8	035326	1
27/64	.4219	2-7/8	4-7/16	035327	1
7/16	.4375	2-15/16	4-1/2	035328	1
29/64	.4531	3	4-5/8	035329	1
15/32	.4688	3-1/8	4-3/4	035330	1
31/64	.4844	3-1/4	4-7/8	035331	1
1/2	.5000	3-3/8	5	035332	1



- TriNADO Drills are the Perfect No-Slip Tool For Your Cordless Drilling Needs
- The TriNADO drill series is longer than screw machine, but shorter than jobber length.
- Available in either Straight or Reduced Shank

Straight Shank



Reduced Shank



T1M, Straight Shank

Packaging: Bulk Master Pack

Size	Decimal Equivalent	Flute Length	Overall Length	Stock#	Pkg Qty
1/16	.0625	7/8	1-7/8	033304.20	144
5/64	.0781	1	2	033305.20	144
3/32	.0938	1-1/4	2-1/4	033306.20	144
7/64	.1094	1-5/16	2-3/8	033307.20	144
1/8	.1250	1-7/16	2-1/2	033308.20	144
9/64	.1406	1-9/16	2-5/8	033309.20	144
5/32	.1562	1-11/16	2-3/4	033310.20	144
11/64	.1719	1-13/16	2-7/8	033311.20	144

3-Flats on Shank

3/16	.1875	1-7/8	3	033312.20	144
13/64	.2031	1-15/16	3-1/8	033313.20	144
7/32	.2188	2	3-1/4	033314.20	144
15/64	.2344	2-1/16	3-3/8	033315.20	144
1/4	.2500	2	3-1/2	033316.20	144
17/64	.2656	2-1/8	3-5/8	033317.20	144
9/32	.2812	2-1/4	3-3/4	033318.20	144
5/16	.3125	2-1/2	4	033320.20	144
11/32	.3438	2-5/8	4-1/8	033322.20	144
3/8	.3750	2-11/16	4-1/4	033324.20	144
13/32	.4062	2-13/16	4-3/8	033326.20	144
7/16	.4375	2-15/16	4-1/2	033328.20	144
15/32	.4688	3-1/8	4-3/4	033330.20	144
1/2	.5000	3-3/8	5	033332.20	144

T8M, 3/8" Reduced Shank

Packaging: Tube

Size	Decimal Equivalent	Flute Length	Overall Length	Stock#	Pkg Qty
27/64	.4219	2-7/8	4-7/16	092627	6
7/16	.4375	2-15/16	4-1/2	092628	6
29/64	.4531	3	4-5/8	092629	6
15/32	.4688	3-1/8	4-3/4	092630	6
31/64	.4844	3-1/4	4-7/8	092631	6
1/2	.5000	3-3/8	5	092632	6

Works Best in This Material

Material	TriNADO
Aluminum/Aluminum Alloys; Bronze, Soft and Medium	
Iron, Cast	✓
Steel, Low and Medium Carbon	✓
Steel, High Alloy	✓
Steel, Stainless and PH	✓
Tough, Medium and High-Tensile Strength Alloys	✓
Wood and Plastic	

• Jobber Drill

• Broca, serie corta

• Foret court



Point: 135° Split Point
 Material: High Speed Steel
 Coating/Finish: Black Oxide
 Other: Heavy-Duty Construction

T1D

Packaging: Tube

Size	Decimal Equivalent	Flute Length	Overall Length	Stock#	Pkg Qty
1/16	.0625	7/8	1-7/8	011404	12
5/64	.0781	1	2	011405	12
3/32	.0938	1-1/4	2-1/4	011406	12
7/64	.1094	1-1/2	2-5/8	011407	12
1/8	.1250	1-5/8	2-3/4	011408	12
9/64	.1406	1-3/4	2-7/8	011409	12
5/32	.1562	2	3-1/8	011410	12
11/64	.1719	2-1/8	3-1/4	011411	12
3/16	.1875	2-5/16	3-1/2	011412	12
13/64	.2031	2-7/16	3-5/8	011413	12
7/32	.2188	2-1/2	3-3/4	011414	12
15/64	.2344	2-5/8	3-7/8	011415	12
1/4	.2500	2-3/4	4	011416	12
17/64	.2656	2-7/8	4-1/8	011417	12
9/32	.2812	2-15/16	4-1/4	011418	12
19/64	.2969	3-1/16	4-3/8	011419	12
5/16	.3125	3-3/16	4-1/2	011420	6
21/64	.3281	3-5/16	4-5/8	011421	6
11/32	.3438	3-7/16	4-3/4	011422	6
23/64	.3594	3-1/2	4-7/8	011423	6
3/8	.3750	3-5/8	5	011424	6
25/64	.3906	3-3/4	5-1/8	011425	6
13/32	.4062	3-7/8	5-1/4	011426	6
27/64	.4219	3-15/16	5-3/8	011427	6
7/16	.4375	4-1/16	5-1/2	011428	6
29/64	.4531	4-3/16	5-5/8	011429	6
15/32	.4688	4-5/16	5-3/4	011430	6
31/64	.4844	4-3/8	5-7/8	011431	6
1/2	.5000	4-1/2	6	011432	6

T1D

Packaging: Bulk Master Pack

Size	Decimal Equivalent	Flute Length	Overall Length	Stock#	Pkg Qty
1/8	.1250	1-5/8	2-3/4	011408.20	288
5/32	.1562	2	3-1/8	011410.20	288
11/64	.1719	2-1/8	3-1/4	011411.20	288
3/16	.1875	2-5/16	3-1/2	011412.20	288
13/64	.2031	2-7/16	3-5/8	011413.20	288
7/32	.2188	2-1/2	3-3/4	011414.20	288
1/4	.2500	2-3/4	4	011416.20	288
9/32	.2812	2-15/16	4-1/4	011418.20	144
5/16	.3125	3-3/16	4-1/2	011420.20	144
11/32	.3438	3-7/16	4-3/4	011422.20	144
23/64	.3594	3-1/2	4-7/8	011423.20	144
3/8	.3750	3-5/8	5	011424.20	144

Works Best in This Material	Heavy-Duty Black Oxide
Aluminum/Aluminum Alloys; Bronze, Soft and Medium	
Iron, Cast	✓
Steel, Low and Medium Carbon	✓
Steel, High Alloy	✓
Steel, Stainless and PH	
Tough, Medium and High-Tensile Strength Alloys	✓
Wood and Plastic	



Black oxide finish provides added lubricity

continued on next page



• Jobber Drill



• Broca, serie corta

• Foret court

Point: 135° Split Point
 Material: High Speed Steel
 Coating/Finish: Black Oxide
 Other: Heavy-Duty Construction

T2D

Packaging: Tube

Size	Decimal Equivalent	Flute Length	Overall Length	Stock#	Pkg Qty
60*	.0400	11/16	1-5/8	012460	12
59*	.0410	11/16	1-5/8	012459	12
58*	.0420	11/16	1-5/8	012458	12
57*	.0430	3/4	1-3/4	012457	12
56*	.0465	3/4	1-3/4	012456	12
55*	.0520	7/8	1-7/8	012455	12
54*	.0550	7/8	1-7/8	012454	12
53*	.0595	7/8	1-7/8	012453	12
52	.0635	7/8	1-7/8	012452	12
51	.0670	1	2	012451	12
50	.0700	1	2	012450	12
49	.0730	1	2	012449	12
48	.0760	1	2	012448	12
47	.0785	1	2	012447	12
46	.0810	1-1/8	2-1/8	012446	12
45	.0820	1-1/8	2-1/8	012445	12
44	.0860	1-1/8	2-1/8	012444	12
43	.0890	1-1/4	2-1/4	012443	12
42	.0935	1-1/4	2-1/4	012442	12
41	.0960	1-3/8	2-3/8	012441	12
40	.0980	1-3/8	2-3/8	012440	12
39	.0995	1-3/8	2-3/8	012439	12
38	.1015	1-7/16	2-1/2	012438	12
37	.1040	1-7/16	2-1/2	012437	12
36	.1065	1-7/16	2-1/2	012436	12
35	.1100	1-1/2	2-5/8	012435	12
34	.1110	1-1/2	2-5/8	012434	12
33	.1130	1-1/2	2-5/8	012433	12
32	.1160	1-5/8	2-3/4	012432	12
31	.1200	1-5/8	2-3/4	012431	12
30	.1285	1-5/8	2-3/4	012430	12
29	.1360	1-3/4	2-7/8	012429	12
28	.1405	1-3/4	2-7/8	012428	12
27	.1440	1-7/8	3	012427	12
26	.1470	1-7/8	3	012426	12
25	.1495	1-7/8	3	012425	12
24	.1520	2	3-1/8	012424	12
23	.1540	2	3-1/8	012423	12
22	.1570	2	3-1/8	012422	12
21	.1590	2-1/8	3-1/4	012421	12
20	.1610	2-1/8	3-1/4	012420	12
19	.1660	2-1/8	3-1/4	012419	12
18	.1695	2-1/8	3-1/4	012418	12
17	.1730	2-3/16	3-3/8	012417	12
16	.1770	2-3/16	3-3/8	012416	12
15	.1800	2-3/16	3-3/8	012415	12
14	.1820	2-3/16	3-3/8	012414	12
13	.1850	2-5/16	3-1/2	012413	12
12	.1890	2-5/16	3-1/2	012412	12
11	.1910	2-5/16	3-1/2	012411	12
10	.1935	2-7/16	3-5/8	012410	12
9	.1960	2-7/16	3-5/8	012409	12
8	.1990	2-7/16	3-5/8	012408	12
7	.2010	2-7/16	3-5/8	012407	12
6	.2040	2-1/2	3-3/4	012406	12
5	.2055	2-1/2	3-3/4	012405	12
4	.2090	2-1/2	3-3/4	012404	12
3	.2130	2-1/2	3-3/4	012403	12
2	.2210	2-5/8	3-7/8	012402	12
1	.2280	2-5/8	3-7/8	012401	12

T3D

Packaging: Tube

Size	Decimal Equivalent	Flute Length	Overall Length	Stock#	Pkg Qty
A	.2340	2-5/8	3-7/8	013401	12
B	.2380	2-3/4	4	013402	12
C	.2420	2-3/4	4	013403	12
D	.2460	2-3/4	4	013404	12
E	.2500	2-3/4	4	013405	12
F	.2570	2-7/8	4-1/8	013406	12
G	.2610	2-7/8	4-1/8	013407	12
H	.2660	2-7/8	4-1/8	013408	12
I	.2720	2-7/8	4-1/8	013409	12
J	.2770	2-7/8	4-1/8	013410	12
K	.2810	2-15/16	4-1/4	013411	12
L	.2900	2-15/16	4-1/4	013412	12
M	.2950	3-1/16	4-3/8	013413	12
N	.3020	3-1/16	4-3/8	013414	12
O	.3160	3-3/16	4-1/2	013415	6
P	.3230	3-5/16	4-5/8	013416	6
Q	.3320	3-7/16	4-3/4	013417	6
R	.3390	3-7/16	4-3/4	013418	6
S	.3480	3-1/2	4-7/8	013419	6
T	.3580	3-1/2	4-7/8	013420	6
U	.3680	3-5/8	5	013421	6
V	.3770	3-5/8	5	013422	6
W	.3860	3-3/4	5-1/8	013423	6
X	.3970	3-3/4	5-1/8	013424	6
Y	.4040	3-7/8	5-1/4	013425	6
Z	.4130	3-7/8	5-1/4	013426	6

Corresponding Sets



Style	Description	# of Pieces	Size Range	Stock#
T19D	Metal Index	13 Piece	1/16"-1/4" by 64ths	099815
T18D	Metal Index	15 Piece	1/16"-1/2" by 32nds	099809
T180D	Metal Index	21 Piece	1/16"-3/8" by 64ths	099836
T17D	Metal Index	29 Piece	1/16"-1/2" by 64ths	099803
T123D	Metal Index	115 Piece	1/16"-1/2" by 64ths, #1-#60, A-Z	090561



Find the Best Drill for Your Job . . . Page 7

*Not split point

• Jobber Drill



• Broca, serie corta

Point: 118° Point
Material: High Speed Steel
Coating/Finish: Black Oxide
Other: General Purpose

• Foret court

T1B

Packaging: Tube

Size	Decimal Equivalent	Flute Length	Overall Length	Stock#	Pkg Qty
1/64	.0156	3/16	3/4	011201	12
1/32	.0312	1/2	1-3/8	011202	12
3/64	.0469	3/4	1-3/4	011203	12
1/16	.0625	7/8	1-7/8	011204	12
5/64	.0781	1	2	011205	12
3/32	.0938	1-1/4	2-1/4	011206	12
7/64	.1094	1-1/2	2-5/8	011207	12
1/8	.1250	1-5/8	2-3/4	011208	12
9/64	.1406	1-3/4	2-7/8	011209	12
5/32	.1562	2	3-1/8	011210	12
11/64	.1719	2-1/8	3-1/4	011211	12
3/16	.1875	2-5/16	3-1/2	011212	12
13/64	.2031	2-7/16	3-5/8	011213	12
7/32	.2188	2-1/2	3-3/4	011214	12
15/64	.2344	2-5/8	3-7/8	011215	12
1/4	.2500	2-3/4	4	011216	12
17/64	.2656	2-7/8	4-1/8	011217	12
9/32	.2812	2-15/16	4-1/4	011218	12
19/64	.2969	3-1/16	4-3/8	011219	12
5/16	.3125	3-3/16	4-1/2	011220	6
21/64	.3281	3-5/16	4-5/8	011221	6
11/32	.3438	3-7/16	4-3/4	011222	6
23/64	.3594	3-1/2	4-7/8	011223	6
3/8	.3750	3-5/8	5	011224	6
25/64	.3906	3-3/4	5-1/8	011225	6
13/32	.4062	3-7/8	5-1/4	011226	6
27/64	.4219	3-15/16	5-3/8	011227	6
7/16	.4375	4-1/16	5-1/2	011228	6
29/64	.4531	4-3/16	5-5/8	011229	6
15/32	.4688	4-5/16	5-3/4	011230	6
31/64	.4844	4-3/8	5-7/8	011231	6
1/2	.5000	4-1/2	6	011232	6

T1B

Packaging: Bulk Master Pack

Size	Decimal Equivalent	Flute Length	Overall Length	Stock#	Pkg Qty
1/32	.0312	1/2	1-3/8	011202.20	288
3/64	.0469	3/4	1-3/4	011203.20	288
1/16	.0625	7/8	1-7/8	011204.20	288
5/64	.0781	1	2	011205.20	288
3/32	.0938	1-1/4	2-1/4	011206.20	288
7/64	.1094	1-1/2	2-5/8	011207.20	288
1/8	.1250	1-5/8	2-3/4	011208.20	288
9/64	.1406	1-3/4	2-7/8	011209.20	288
5/32	.1562	2	3-1/8	011210.20	288
11/64	.1719	2-1/8	3-1/4	011211.20	288
3/16	.1875	2-5/16	3-1/2	011212.20	288
13/64	.2031	2-7/16	3-5/8	011213.20	288
7/32	.2188	2-1/2	3-3/4	011214.20	288
15/64	.2344	2-5/8	3-7/8	011215.20	288
1/4	.2500	2-3/4	4	011216.20	288
17/64	.2656	2-7/8	4-1/8	011217.20	144
9/32	.2812	2-15/16	4-1/4	011218.20	144
19/64	.2969	3-1/16	4-3/8	011219.20	144
5/16	.3125	3-3/16	4-1/2	011220.20	144
21/64	.3281	3-5/16	4-5/8	011221.20	144
11/32	.3438	3-7/16	4-3/4	011222.20	144
23/64	.3594	3-1/2	4-7/8	011223.20	144
3/8	.3750	3-5/8	5	011224.20	144
25/64	.3906	3-3/4	5-1/8	011225.20	144
13/32	.4062	3-7/8	5-1/4	011226.20	144
27/64	.4219	3-15/16	5-3/8	011227.20	144
7/16	.4375	4-1/16	5-1/2	011228.20	144
29/64	.4531	4-3/16	5-5/8	011229.20	144
15/32	.4688	4-5/16	5-3/4	011230.20	144
31/64	.4844	4-3/8	5-7/8	011231.20	144
1/2	.5000	4-1/2	6	011232.20	144



Corresponding Sets

Style	Description	# of Pieces	Size Range	Stock#
T17B	Metal Index	29 Piece	1/16"-1/2" by 64ths	099802
T18B	Metal Index	15 Piece	1/16"-1/2" by 32nds	099808
T19B	Metal Index	13 Piece	1/16"-1/4" by 64ths	099814
T22B	Metal Index	60 Piece	#1 - #60	099820
T25B	Metal Index	26 Piece	A - Z	099827
T123B	Metal Index	115 Piece	1/16"-1/2 by 64ths, #1 #60, A-Z	099832
T180B	Metal Index	21 Piece	1/16"-3/8" by 64ths	099835
T815B*	Metal Index	15 Piece	1/16"-1/2" by 32nds,	099812
T829B*	Metal Index	29 Piece	1/16"-1/2" by 64ths	099833

*3/8" Reduced Shank

BP1B

Packaging: Tube

Size	Decimal Equivalent	Flute Length	Overall Length	Stock#	Pkg Qty
5/16	.3125	3-3/16	4-1/2	011320	1
21/64	.3281	3-5/16	4-5/8	011321	1
11/32	.3438	3-7/16	4-3/4	011322	1
23/64	.3594	3-1/2	4-7/8	011323	1
3/8	.3750	3-5/8	5	011324	1
25/64	.3906	3-3/4	5-1/8	011325	1
13/32	.4062	3-7/8	5-1/4	011326	1
27/64	.4219	3-15/16	5-3/8	011327	1
7/16	.4375	4-1/16	5-1/2	011328	1
29/64	.4531	4-3/16	5-5/8	011329	1
15/32	.4688	4-5/16	5-3/4	011330	1
31/64	.4844	4-3/8	5-7/8	011331	1
1/2	.5000	4-1/2	6	011332	1

continued on next page

• Jobber Drill



• Broca, serie corta

Point: 118° Point
 Material: High Speed Steel
 Coating/Finish: Black Oxide
 Other: General Purpose

• Foret court

T2B

Packaging: Tube

Size	Decimal Equivalent	Flute Length	Overall Length	Stock#	Pkg Qty
60	.0400	11/16	1-5/8	012260	12
59	.0410	11/16	1-5/8	012259	12
58	.0420	11/16	1-5/8	012258	12
57	.0430	3/4	1-3/4	012257	12
56	.0465	3/4	1-3/4	012256	12
55	.0520	7/8	1-7/8	012255	12
54	.0550	7/8	1-7/8	012254	12
53	.0595	7/8	1-7/8	012253	12
52	.0635	7/8	1-7/8	012252	12
51	.0670	1	2	012251	12
50	.0700	1	2	012250	12
49	.0730	1	2	012249	12
48	.0760	1	2	012248	12
47	.0785	1	2	012247	12
46	.0810	1-1/8	2-1/8	012246	12
45	.0820	1-1/8	2-1/8	012245	12
44	.0860	1-1/8	2-1/8	012244	12
43	.0890	1-1/4	2-1/4	012243	12
42	.0935	1-1/4	2-1/4	012242	12
41	.0960	1-3/8	2-3/8	012241	12
40	.0980	1-3/8	2-3/8	012240	12
39	.0995	1-3/8	2-3/8	012239	12
38	.1015	1-7/16	2-1/2	012238	12
37	.1040	1-7/16	2-1/2	012237	12
36	.1065	1-7/16	2-1/2	012236	12
35	.1100	1-1/2	2-5/8	012235	12
34	.1110	1-1/2	2-5/8	012234	12
33	.1130	1-1/2	2-5/8	012233	12
32	.1160	1-5/8	2-3/4	012232	12
31	.1200	1-5/8	2-3/4	012231	12
30	.1285	1-5/8	2-3/4	012230	12
29	.1360	1-3/4	2-7/8	012229	12
28	.1405	1-3/4	2-7/8	012228	12
27	.1440	1-7/8	3	012227	12
26	.1470	1-7/8	3	012226	12
25	.1495	1-7/8	3	012225	12
24	.1520	2	3-1/8	012224	12
23	.1540	2	3-1/8	012223	12
22	.1570	2	3-1/8	012222	12
21	.1590	2-1/8	3-1/4	012221	12
20	.1610	2-1/8	3-1/4	012220	12
19	.1660	2-1/8	3-1/4	012219	12
18	.1695	2-1/8	3-1/4	012218	12
17	.1730	2-3/16	3-3/8	012217	12
16	.1770	2-3/16	3-3/8	012216	12
15	.1800	2-3/16	3-3/8	012215	12
14	.1820	2-3/16	3-3/8	012214	12
13	.1850	2-5/16	3-1/2	012213	12
12	.1890	2-5/16	3-1/2	012212	12
11	.1910	2-5/16	3-1/2	012211	12
10	.1935	2-7/16	3-5/8	012210	12
9	.1960	2-7/16	3-5/8	012209	12
8	.1990	2-7/16	3-5/8	012208	12
7	.2010	2-7/16	3-5/8	012207	12
6	.2040	2-1/2	3-3/4	012206	12
5	.2055	2-1/2	3-3/4	012205	12
4	.2090	2-1/2	3-3/4	012204	12
3	.2130	2-1/2	3-3/4	012203	12
2	.2210	2-5/8	3-7/8	012202	12
1	.2280	2-5/8	3-7/8	012201	12

T2B

Packaging: Bulk Master Pack

Size	Decimal Equivalent	Flute Length	Overall Length	Stock#	Pkg Qty
59	.0410	11/16	1-5/8	012259.20	288
58	.0420	11/16	1-5/8	012258.20	288
57	.0430	3/4	1-3/4	012257.20	288
56	.0465	3/4	1-3/4	012256.20	288
55	.0520	7/8	1-7/8	012255.20	288
54	.0550	7/8	1-7/8	012254.20	288
53	.0595	7/8	1-7/8	012253.20	288
52	.0635	7/8	1-7/8	012252.20	288
40	.0980	1-3/8	2-3/8	012240.20	288
36	.1065	1-7/16	2-1/2	012236.20	288
31	.1200	1-5/8	2-3/4	012231.20	288
30	.1285	1-5/8	2-3/4	012230.20	288
29	.1360	1-3/4	2-7/8	012229.20	288
28	.1405	1-3/4	2-7/8	012228.20	288
25	.1495	1-7/8	3	012225.20	288
21	.1590	2-1/8	3-1/4	012221.20	288
20	.1610	2-1/8	3-1/4	012220.20	288
16	.1770	2-3/16	3-3/8	012216.20	288
10	.1935	2-7/16	3-5/8	012210.20	288
7	.2010	2-7/16	3-5/8	012207.20	288
6	.2040	2-1/2	3-3/4	012206.20	288
2	.2210	2-5/8	3-7/8	012202.20	288
1	.2280	2-5/8	3-7/8	012201.20	288

T3B

Packaging: Tube

Size	Decimal Equivalent	Flute Length	Overall Length	Stock#	Pkg Qty
A	.2340	2-5/8	3-7/8	013201	12
B	.2380	2-3/4	4	013202	12
C	.2420	2-3/4	4	013203	12
D	.2460	2-3/4	4	013204	12
E	.2500	2-3/4	4	013205	12
F	.2570	2-7/8	4-1/8	013206	12
G	.2610	2-7/8	4-1/8	013207	12
H	.2660	2-7/8	4-1/8	013208	12
I	.2720	2-7/8	4-1/8	013209	12
J	.2770	2-7/8	4-1/8	013210	12
K	.2810	2-15/16	4-1/4	013211	12
L	.2900	2-15/16	4-1/4	013212	12
M	.2950	3-1/16	4-3/8	013213	12
N	.3020	3-1/16	4-3/8	013214	12
O	.3160	3-3/16	4-1/2	013215	6
P	.3230	3-5/16	4-5/8	013216	6
Q	.3320	3-7/16	4-3/4	013217	6
R	.3390	3-7/16	4-3/4	013218	6
S	.3480	3-1/2	4-7/8	013219	6
T	.3580	3-1/2	4-7/8	013220	6
U	.3680	3-5/8	5	013221	6
V	.3770	3-5/8	5	013222	6
W	.3860	3-3/4	5-1/8	013223	6
X	.3970	3-3/4	5-1/8	013224	6
Y	.4040	3-7/8	5-1/4	013225	6
Z	.4130	3-7/8	5-1/4	013226	6

• Jobber Drill

• Broca, serie corta

• Foret court



Point: 118° Point
 Material: High Speed Steel
 Coating/Finish: Bright Finish
 Other: General Purpose

T1

Packaging: Tube

Size	Decimal Equivalent	Flute Length	Overall Length	Stock#	Pkg Qty
1/64	.0156	3/16	3/4	011001	12
1/32	.0312	1/2	1-3/8	011002	12
3/64	.0469	3/4	1-3/4	011003	12
1/16	.0625	7/8	1-7/8	011004	12
5/64	.0781	1	2	011005	12
3/32	.0938	1-1/4	2-1/4	011006	12
7/64	.1094	1-1/2	2-5/8	011007	12
1/8	.1250	1-5/8	2-3/4	011008	12
9/64	.1406	1-3/4	2-7/8	011009	12
5/32	.1562	2	3-1/8	011010	12
11/64	.1719	2-1/8	3-1/4	011011	12
3/16	.1875	2-5/16	3-1/2	011012	12
13/64	.2031	2-7/16	3-5/8	011013	12
7/32	.2188	2-1/2	3-3/4	011014	12
15/64	.2344	2-5/8	3-7/8	011015	12
1/4	.2500	2-3/4	4	011016	12
17/64	.2656	2-7/8	4-1/8	011017	12
9/32	.2812	2-15/16	4-1/4	011018	12
19/64	.2969	3-1/16	4-3/8	011019	12
5/16	.3125	3-3/16	4-1/2	011020	6
21/64	.3281	3-5/16	4-5/8	011021	6
11/32	.3438	3-7/16	4-3/4	011022	6
23/64	.3594	3-1/2	4-7/8	011023	6
3/8	.3750	3-5/8	5	011024	6
25/64	.3906	3-3/4	5-1/8	011025	6
13/32	.4062	3-7/8	5-1/4	011026	6
27/64	.4219	3-15/16	5-3/8	011027	6
7/16	.4375	4-1/16	5-1/2	011028	6
29/64	.4531	4-3/16	5-5/8	011029	6
15/32	.4688	4-5/16	5-3/4	011030	6
31/64	.4844	4-3/8	5-7/8	011031	6
1/2	.5000	4-1/2	6	011032	6

T1

Packaging: Bulk Master Pack

Size	Decimal Equivalent	Flute Length	Overall Length	Stock#	Pkg Qty
13/64	.2031	2-7/16	3-5/8	011013.20	288
7/32	.2188	2-1/2	3-3/4	011014.20	288
15/64	.2344	2-5/8	3-7/8	011015.20	288
1/4	.2500	2-3/4	4	011016.20	288
17/64	.2656	2-7/8	4-1/8	011017.20	144
9/32	.2812	2-15/16	4-1/4	011018.20	144
19/64	.2969	3-1/16	4-3/8	011019.20	144
5/16	.3125	3-3/16	4-1/2	011020.20	144
21/64	.3281	3-5/16	4-5/8	011021.20	144
11/32	.3438	3-7/16	4-3/4	011022.20	144
23/64	.3594	3-1/2	4-7/8	011023.20	144
3/8	.3750	3-5/8	5	011024.20	144
25/64	.3906	3-3/4	5-1/8	011025.20	144
13/32	.4062	3-7/8	5-1/4	011026.20	144
27/64	.4219	3-15/16	5-3/8	011027.20	144
7/16	.4375	4-1/16	5-1/2	011028.20	144
29/64	.4531	4-3/16	5-5/8	011029.20	144
15/32	.4688	4-5/16	5-3/4	011030.20	144
31/64	.4844	4-3/8	5-7/8	011031.20	144
1/2	.5000	4-1/2	6	011032.20	144

BP1

Packaging: Tube

Size	Decimal Equivalent	Flute Length	Overall Length	Stock#	Pkg Qty
1/16	.0625	7/8	1-7/8	011604	2
5/64	.0781	1	2	011605	2
3/32	.0938	1-1/4	2-1/4	011606	2
7/64	.1094	1-1/2	2-5/8	011607	2
1/8	.1250	1-5/8	2-3/4	011608	2
9/64	.1406	1-3/4	2-7/8	011609	1
5/32	.1562	2	3-1/8	011610	1
11/64	.1719	2-1/8	3-1/4	011611	1
3/16	.1875	2-5/16	3-1/2	011612	1
13/64	.2031	2-7/16	3-5/8	011613	1
7/32	.2188	2-1/2	3-3/4	011614	1
15/64	.2344	2-5/8	3-7/8	011615	1
1/4	.2500	2-3/4	4	011616	1
17/64	.2656	2-7/8	4-1/8	011617	1
9/32	.2812	2-15/16	4-1/4	011618	1
19/64	.2969	3-1/16	4-3/8	011619	1
5/16	.3125	3-3/16	4-1/2	011620	1
21/64	.3281	3-5/16	4-5/8	011621	1
11/32	.3438	3-7/16	4-3/4	011622	1
23/64	.3594	3-1/2	4-7/8	011623	1
3/8	.3750	3-5/8	5	011624	1
25/64	.3906	3-3/4	5-1/8	011625	1
13/32	.4062	3-7/8	5-1/4	011626	1
27/64	.4219	3-15/16	5-3/8	011627	1
7/16	.4375	4-1/16	5-1/2	011628	1
29/64	.4531	4-3/16	5-5/8	011629	1
15/32	.4688	4-5/16	5-3/4	011630	1
31/64	.4844	4-3/8	5-7/8	011631	1
1/2	.5000	4-1/2	6	011632	1

T1

Packaging: Bulk Master Pack

Size	Decimal Equivalent	Flute Length	Overall Length	Stock#	Pkg Qty
1/32	.0312	1/2	1-3/8	011002.20	288
3/64	.0469	3/4	1-3/4	011003.20	288
1/16	.0625	7/8	1-7/8	011004.20	288
5/64	.0781	1	2	011005.20	288
3/32	.0938	1-1/4	2-1/4	011006.20	288
7/64	.1094	1-1/2	2-5/8	011007.20	288
1/8	.1250	1-5/8	2-3/4	011008.20	288
9/64	.1406	1-3/4	2-7/8	011009.20	288
5/32	.1562	2	3-1/8	011010.20	288
11/64	.1719	2-1/8	3-1/4	011011.20	288
3/16	.1875	2-5/16	3-1/2	011012.20	288

continued on next page



• Jobber Drill



• Broca, serie corta

Point: 118° Point
 Material: High Speed Steel
 Coating/Finish: Bright Finish
 Other: General Purpose

• Foret court

T2

Packaging: Tube

Size	Decimal Equivalent	Flute Length	Overall Length	Stock#	Pkg Qty
80	.0135	1/8	3/4	012080	12
79	.0145	1/8	3/4	012079	12
78	.0160	3/16	7/8	012078	12
77	.0180	3/16	7/8	012077	12
76	.0200	3/16	7/8	012076	12
75	.0210	1/4	1	012075	12
74	.0225	1/4	1	012074	12
73	.0240	5/16	1-1/8	012073	12
72	.0250	5/16	1-1/8	012072	12
71	.0260	3/8	1-1/4	012071	12
70	.0280	3/8	1-1/4	012070	12
69	.0292	1/2	1-3/8	012069	12
68	.0310	1/2	1-3/8	012068	12
67	.0320	1/2	1-3/8	012067	12
66	.0330	1/2	1-3/8	012066	12
65	.0350	5/8	1-1/2	012065	12
64	.0360	5/8	1-1/2	012064	12
63	.0370	5/8	1-1/2	012063	12
62	.0380	5/8	1-1/2	012062	12
61	.0390	11/16	1-5/8	012061	12
60	.0400	11/16	1-5/8	012060	12
59	.0410	11/16	1-5/8	012059	12
58	.0420	11/16	1-5/8	012058	12
57	.0430	3/4	1-3/4	012057	12
56	.0465	3/4	1-3/4	012056	12
55	.0520	7/8	1-7/8	012055	12
54	.0550	7/8	1-7/8	012054	12
53	.0595	7/8	1-7/8	012053	12
52	.0635	7/8	1-7/8	012052	12
51	.0670	1	2	012051	12
50	.0700	1	2	012050	12
49	.0730	1	2	012049	12
48	.0760	1	2	012048	12
47	.0785	1	2	012047	12
46	.0810	1-1/8	2-1/8	012046	12
45	.0820	1-1/8	2-1/8	012045	12
44	.0860	1-1/8	2-1/8	012044	12
43	.0890	1-1/4	2-1/4	012043	12
42	.0935	1-1/4	2-1/4	012042	12
41	.0960	1-3/8	2-3/8	012041	12
40	.0980	1-3/8	2-3/8	012040	12
39	.0995	1-3/8	2-3/8	012039	12
38	.1015	1-7/16	2-1/2	012038	12
37	.1040	1-7/16	2-1/2	012037	12
36	.1065	1-7/16	2-1/2	012036	12
35	.1100	1-1/2	2-5/8	012035	12
34	.1110	1-1/2	2-5/8	012034	12
33	.1130	1-1/2	2-5/8	012033	12
32	.1160	1-5/8	2-3/4	012032	12
31	.1200	1-5/8	2-3/4	012031	12
30	.1285	1-5/8	2-3/4	012030	12
29	.1405	1-3/4	2-7/8	012029	12
28	.1405	1-3/4	2-7/8	012028	12
27	.1440	1-7/8	3	012027	12
26	.1470	1-7/8	3	012026	12
25	.1495	1-7/8	3	012025	12
24	.1520	2	3-1/8	012024	12
23	.1540	2	3-1/8	012023	12
22	.1570	2	3-1/8	012022	12
21	.1590	2-1/8	3-1/4	012021	12
20	.1610	2-1/8	3-1/4	012020	12

T2

Packaging: Tube (con't)

Size	Decimal Equivalent	Flute Length	Overall Length	Stock#	Pkg Qty
19	.1660	2-1/8	3-1/4	012019	12
18	.1695	2-1/8	3-1/4	012018	12
17	.1730	2-3/16	3-3/8	012017	12
16	.1770	2-3/16	3-3/8	012016	12
15	.1800	2-3/16	3-3/8	012015	12
14	.1820	2-3/16	3-3/8	012014	12
13	.1850	2-5/16	3-1/2	012013	12
12	.1890	2-5/16	3-1/2	012012	12
11	.1910	2-5/16	3-1/2	012011	12
10	.1935	2-7/16	3-5/8	012010	12
9	.1960	2-7/16	3-5/8	012009	12
8	.1990	2-7/16	3-5/8	012008	12
7	.2010	2-7/16	3-5/8	012007	12
6	.2040	2-1/2	3-3/4	012006	12
5	.2055	2-1/2	3-3/4	012005	12
4	.2090	2-1/2	3-3/4	012004	12
3	.2130	2-1/2	3-3/4	012003	12
2	.2210	2-5/8	3-7/8	012002	12
1	.2280	2-5/8	3-7/8	012001	12

T2

Packaging: Bulk Master Pack

Size	Decimal Equivalent	Flute Length	Overall Length	Stock#	Pkg Qty
77	.0180	3/16	7/8	012077.20	288
76	.0200	3/16	7/8	012076.20	288
74	.0225	1/4	1	012074.20	288
73	.0240	5/16	1-1/8	012073.20	288
70	.0280	3/8	1-1/4	012070.20	288
69	.0292	1/2	1-3/8	012069.20	288
67	.0320	1/2	1-3/8	012067.20	288
66	.0330	1/2	1-3/8	012066.20	288
63	.0370	5/8	1-1/2	012063.20	288
60	.0400	11/16	1-5/8	012060.20	288
58	.0420	11/16	1-5/8	012058.20	288
56	.0465	3/4	1-3/4	012056.20	288
55	.0520	7/8	1-7/8	012055.20	288
54	.0550	7/8	1-7/8	012054.20	288
53	.0595	7/8	1-7/8	012053.20	288
50	.0700	1	2	012050.20	288
44	.0860	1-1/8	2-1/8	012044.20	288
36	.1065	1-7/16	2-1/2	012036.20	288
35	.1100	1-1/2	2-5/8	012035.20	288
32	.1160	1-5/8	2-3/4	012032.20	288
31	.1200	1-5/8	2-3/4	012031.20	288
29	.1360	1-3/4	2-7/8	012029.20	288
25	.1495	1-7/8	3	012025.20	288
21	.1590	2-1/8	3-1/4	012021.20	288
10	.1935	2-7/16	3-5/8	012010.20	288
7	.2010	2-7/16	3-5/8	012007.20	288

• Jobber Drill

• Broca, serie corta

• Foret court



Point: 118° Point
Material: High Speed Steel
Coating/Finish: Bright Finish
Other: General Purpose

T3

Packaging: Tube

Size	Decimal Equivalent	Flute Length	Overall Length	Stock#	Pkg Qty
A	.2340	2-5/8	3-7/8	013001	12
B	.2380	2-3/4	4	013002	12
C	.2420	2-3/4	4	013003	12
D	.2460	2-3/4	4	013004	12
E	.2500	2-3/4	4	013005	12
F	.2570	2-7/8	4-1/8	013006	12
G	.2610	2-7/8	4-1/8	013007	12
H	.2660	2-7/8	4-1/8	013008	12
I	.2720	2-7/8	4-1/8	013009	12
J	.2770	2-7/8	4-1/8	013010	12
K	.2810	2-15/16	4-1/4	013011	12
L	.2900	2-15/16	4-1/4	013012	12
M	.2950	3-1/16	4-3/8	013013	12
N	.3020	3-1/16	4-3/8	013014	12
O	.3160	3-3/16	4-1/2	013015	6
P	.3230	3-5/16	4-5/8	013016	6
Q	.3320	3-7/16	4-3/4	013017	6
R	.3390	3-7/16	4-3/4	013018	6
S	.3480	3-1/2	4-7/8	013019	6
T	.3580	3-1/2	4-7/8	013020	6
U	.3680	3-5/8	5	013021	6
V	.3770	3-5/8	5	013022	6
W	.3860	3-3/4	5-1/8	013023	6
X	.3970	3-3/4	5-1/8	013024	6
Y	.4040	3-7/8	5-1/4	013025	6
Z	.4130	3-7/8	5-1/4	013026	6

MM1 (ANSI)

Packaging: Tube

Size	Decimal Equivalent	Flute Length	Overall Length	Stock#	Pkg Qty
1.00	.0394	17	41	013910	12
1.20	.0472	22	48	013912	12
1.50	.0591	22	48	013915	12
2.00	.0787	25	51	013920	12
2.50	.0984	35	60	013925	12
3.00	.1181	41	70	013930	12
3.30	.1299	44	73	013933	12
3.50	.1378	44	73	013935	12
4.00	.1575	54	83	013940	12
4.20	.1654	54	83	013942	12
4.50	.1772	56	86	013945	12
5.00	.1969	62	92	013950	12
5.10	.2008	62	92	013951	12
5.30	.2087	64	95	013953	12
5.50	.2165	64	95	013955	12
6.00	.2362	70	102	013960	12
6.50	.2559	73	105	013965	12
6.90	.2717	73	105	013969	6
7.00	.2756	73	105	013970	6
7.20	.2835	75	108	013972	6
7.50	.2953	78	111	013975	6
8.00	.3150	81	114	013980	6
8.30	.3268	84	117	013983	6
8.50	.3346	87	121	013985	6
9.00	.3543	89	124	013990	6
10.00	.3937	95	130	013800	6
10.50	.4134	98	133	013805	6
11.00	.4331	103	140	013810	6
11.50	.4528	106	143	013811	6
12.00	.4724	111	149	013812	6
12.50	.4921	114	152	013813	6
13.00	.5118	114	152	013814	1

Corresponding Sets



Style	Description	# of Pieces	Size Range	Stock#
SAD13	Select-A-Drill	13 Piece	1/16"-1/4" by 64ths	090490
SAD21	Select-A-Drill	21 Piece	1/16"-3/8" by 64ths	090491
T14P*	Metal Index	14 Piece	1/16", 5/64", 3/32", 7/64", 1/8", 9/64", 5/32", 3/16", 7/32", 1/4", 5/16", 3/8", 7/16", 1/2"	090614
T17	Metal Index	29 Piece	1/16"-1/2" by 64ths	090517
T18	Metal Index	15 Piece	1/16"-1/2" by 32nds	090518
T19	Metal Index	13 Piece	1/16"-1/4" by 64ths	090519
T22	Metal Index	60 Piece	#1-#60	090522
T23	Metal Index	20 Piece	#61-#80	090523
T180	Metal Index	21 Piece	1/16"-3/8" by 64ths	090580
T123	Metal Index	115 Piece	1/16"-1/2" by 64ths, #1-#60, A-Z	090560
T815	Metal Index	15 Piece	1/16"-1/2" by 32nds, with 3/8" reduced shank	090815
T829	Metal Index	29 Piece	1/16"-1/2" by 64ths, with 3/8" reduced shank	090829

*Sizes over 1/4" are 1/4" reduced shank

Works Best in This Material	General Purpose Bright
Aluminum/Aluminum Alloys; Bronze, Soft and Medium	✓
Wood and Plastic	✓



• Jobber Drill



• Broca, serie corta

Point: 135° Split Point
 Material: Cobalt, High Speed Steel
 Coating/Finish: Bronze Oxide
 Other: Heavy-Duty Construction

• Foret court

T1C

Packaging: Tube

T1C Size	Decimal Equivalent	Flute Length	Overall Length	Stock#	Pkg Qty
1/16	.0625	7/8	1-7/8	011504	12
5/64	.0781	1	2	011505	12
3/32	.0938	1-1/4	2-1/4	011506	12
7/64	.1094	1-1/2	2-5/8	011507	12
1/8	.1250	1-5/8	2-3/4	011508	12
9/64	.1406	1-3/4	2-7/8	011509	12
5/32	.1562	2	3-1/8	011510	12
11/64	.1719	2-1/8	3-1/4	011511	12
3/16	.1875	2-5/16	3-1/2	011512	12
13/64	.2031	2-7/16	3-5/8	011513	12
7/32	.2188	2-1/2	3-3/4	011514	12
15/64	.2344	2-5/8	3-7/8	011515	12
1/4	.2500	2-3/4	4	011516	12
17/64	.2656	2-7/8	4-1/8	011517	12
9/32	.2812	2-15/16	4-1/4	011518	12
19/64	.2969	3-1/16	4-3/8	011519	12
5/16	.3125	3-3/16	4-1/2	011520	6
21/64	.3281	3-5/16	4-5/8	011521	6
11/32	.3438	3-7/16	4-3/4	011522	6
23/64	.3594	3-1/2	4-7/8	011523	6
3/8	.3750	3-5/8	5	011524	6
25/64	.3906	3-3/4	5-1/8	011525	6
13/32	.4062	3-7/8	5-1/4	011526	6
27/64	.4219	3-15/16	5-3/8	011527	6
7/16	.4375	4-1/16	5-1/2	011528	6
29/64	.4531	4-3/16	5-5/8	011529	6
15/32	.4688	4-5/16	5-3/4	011530	6
31/64	.4844	4-3/8	5-7/8	011531	6
1/2	.5000	4-1/2	6	011532	6

T1C

Packaging: Bulk Master Pack

Size	Decimal Equivalent	Flute Length	Overall Length	Stock#	Pkg Qty
1/16	.0625	7/8	1-7/8	011504.20	288
5/64	.0781	1	2	011505.20	288
3/32	.0938	1-1/4	2-1/4	011506.20	288
7/64	.1094	1-1/2	2-5/8	011507.20	288
1/8	.1250	1-5/8	2-3/4	011508.20	288
9/64	.1406	1-3/4	2-7/8	011509.20	288
5/32	.1562	2	3-1/8	011510.20	288
11/64	.1719	2-1/8	3-1/4	011511.20	288
3/16	.1875	2-5/16	3-1/2	011512.20	288
13/64	.2031	2-7/16	3-5/8	011513.20	288
7/32	.2188	2-1/2	3-3/4	011514.20	288
15/64	.2344	2-5/8	3-7/8	011515.20	288
1/4	.2500	2-3/4	4	011516.20	288
17/64	.2656	2-7/8	4-1/8	011517.20	144
9/32	.2812	2-15/16	4-1/4	011518.20	144
19/64	.2969	3-1/16	4-3/8	011519.20	144
5/16	.3125	3-3/16	4-1/2	011520.20	144
21/64	.3281	3-5/16	4-5/8	011521.20	144
11/32	.3438	3-7/16	4-3/4	011522.20	144
23/64	.3594	3-1/2	4-7/8	011523.20	144
3/8	.3750	3-5/8	5	011524.20	144
25/64	.3906	3-3/4	5-1/8	011525.20	144
13/32	.4062	3-7/8	5-1/4	011526.20	144

T1C

Packaging: Bulk Master Pack

Size	Decimal Equivalent	Flute Length	Overall Length	Stock#	Pkg Qty
27/64	.4219	3-15/16	5-3/8	011527.20	144
7/16	.4375	4-1/16	5-1/2	011528.20	144
29/64	.4531	4-3/16	5-5/8	011529.20	144
15/32	.4688	4-5/16	5-3/4	011530.20	144
31/64	.4844	4-3/8	5-7/8	011531.20	144
1/2	.5000	4-1/2	6	011532.20	144

BP1C

Packaging: Tube

Size	Decimal Equivalent	Flute Length	Overall Length	Stock#	Pkg Qty
1/16	.0625	7/8	1-7/8	014204	1
5/64	.0781	1	2	014205	1
3/32	.0938	1-1/4	2-1/4	014206	1
7/64	.1094	1-1/2	2-5/8	014207	1
1/8	.1250	1-5/8	2-3/4	014208	1
9/64	.1406	1-3/4	2-7/8	014209	1
5/32	.1562	2	3-1/8	014210	1
11/64	.1719	2-1/8	3-1/4	014211	1
3/16	.1875	2-5/16	3-1/2	014212	1
13/64	.2031	2-7/16	3-5/8	014213	1
7/32	.2188	2-1/2	3-3/4	014214	1
15/64	.2344	2-5/8	3-7/8	014215	1
1/4	.2500	2-3/4	4	014216	1
17/64	.2656	2-7/8	4-1/8	014217	1
9/32	.2812	2-15/16	4-1/4	014218	1
19/64	.2969	3-1/16	4-3/8	014219	1
5/16	.3125	3-3/16	4-1/2	014220	1
21/64	.3281	3-5/16	4-5/8	014221	1
11/32	.3438	3-7/16	4-3/4	014222	1
23/64	.3594	3-1/2	4-7/8	014223	1
3/8	.3750	3-5/8	5	014224	1
25/64	.3906	3-3/4	5-1/8	014225	1
13/32	.4062	3-7/8	5-1/4	014226	1
27/64	.4219	3-15/16	5-3/8	014227	1
7/16	.4375	4-1/16	5-1/2	014228	1
29/64	.4531	4-3/16	5-5/8	014229	1
15/32	.4688	4-5/16	5-3/4	014230	1
31/64	.4844	4-3/8	5-7/8	014231	1
1/2	.5000	4-1/2	6	014232	1

Corresponding Sets

Style	Description	# of Pieces	Size Range	Stock#
T19C	Metal Index	13 Piece	1/16"-1/4" by 64ths	099823
T18C	Metal Index	15 Piece	1/16"-1/2" by 32nds	099826
T180C	Metal Index	21 Piece	1/16"-3/8" by 64ths	099825
T17C	Metal Index	29 Piece	1/16"-1/2" by 64ths	099822
T123C	Metal Index	115 Piece	1/16"-1/2" by 64ths, #1-#60, A-Z	099831



continued on next page

• Jobber Drill



• Broca, serie corta

Point: 135° Split Point
 Material: Cobalt, High Speed Steel
 Coating/Finish: Bronze Oxide
 Other: Heavy-Duty Construction

• Foret court

T2C

Packaging: Tube

Size	Decimal Equivalent	Flute Length	Overall Length	Stock#	Pkg Qty
60	.0400	11/16	1-5/8	011760	12
59	.0410	11/16	1-5/8	011759	12
58	.0420	11/16	1-5/8	011758	12
57	.0430	3/4	1-3/4	011757	12
56	.0465	3/4	1-3/4	011756	12
55	.0520	7/8	1-7/8	011755	12
54	.0550	7/8	1-7/8	011754	12
53	.0595	7/8	1-7/8	011753	12
52	.0635	7/8	1-7/8	011752	12
51	.0670	1	2	011751	12
50	.0700	1	2	011750	12
49	.0730	1	2	011749	12
48	.0760	1	2	011748	12
47	.0785	1	2	011747	12
46	.0810	1-1/8	2-1/8	011746	12
45	.0820	1-1/8	2-1/8	011745	12
44	.0860	1-1/8	2-1/8	011744	12
43	.0890	1-1/4	2-1/4	011743	12
42	.0935	1-1/4	2-1/4	011742	12
41	.0960	1-3/8	2-3/8	011741	12
40	.0980	1-3/8	2-3/8	011740	12
39	.0995	1-3/8	2-3/8	011739	12
38	.1015	1-7/16	2-1/2	011738	12
37	.1040	1-7/16	2-1/2	011737	12
36	.1065	1-7/16	2-1/2	011736	12
35	.1100	1-1/2	2-5/8	011735	12
34	.1110	1-1/2	2-5/8	011734	12
33	.1130	1-1/2	2-5/8	011733	12
32	.1160	1-5/8	2-3/4	011732	12
31	.1200	1-5/8	2-3/4	011731	12
30	.1285	1-5/8	2-3/4	011730	12
29	.1360	1-3/4	2-7/8	011729	12
28	.1405	1-3/4	2-7/8	011728	12
27	.1440	1-7/8	3	011727	12
26	.1470	1-7/8	3	011726	12
25	.1495	1-7/8	3	011725	12
24	.1520	2	3-1/8	011724	12
23	.1540	2	3-1/8	011723	12
22	.1570	2	3-1/8	011722	12
21	.1590	2-1/8	3-1/4	011721	12
20	.1610	2-1/8	3-1/4	011720	12
19	.1660	2-1/8	3-1/4	011719	12
18	.1695	2-1/8	3-1/4	011718	12
17	.1730	2-3/16	3-3/8	011717	12
16	.1770	2-3/16	3-3/8	011716	12
15	.1800	2-3/16	3-3/8	011715	12
14	.1820	2-3/16	3-3/8	011714	12
13	.1850	2-5/16	3-1/2	011713	12
12	.1890	2-5/16	3-1/2	011712	12
11	.1910	2-5/16	3-1/2	011711	12
10	.1935	2-7/16	3-5/8	011710	12
9	.1960	2-7/16	3-5/8	011709	12
8	.1990	2-7/16	3-5/8	011708	12
7	.2010	2-7/16	3-5/8	011707	12
6	.2040	2-1/2	3-3/4	011706	12
5	.2055	2-1/2	3-3/4	011705	12
4	.2090	2-1/2	3-3/4	011704	12
3	.2130	2-1/2	3-3/4	011703	12
2	.2210	2-5/8	3-7/8	011702	12
1	.2280	2-5/8	3-7/8	011701	12

T2C

Packaging: Bulk Master Pack

Size	Decimal Equivalent	Flute Length	Overall Length	Stock#	Pkg Qty
50	.0700	1	2	011750.20	288
40	.0980	1-3/8	2-3/8	011740.20	288
36	.1065	1-7/16	2-1/2	011736.20	288
31	.1200	1-5/8	2-3/4	011731.20	288
30	.1285	1-5/8	2-3/4	011730.20	288
29	.1360	1-3/4	2-7/8	011729.20	288
27	.1440	1-7/8	3	011727.20	288
26	.1470	1-7/8	3	011726.20	288
25	.1495	1-7/8	3	011725.20	288
21	.1590	2-1/8	3-1/4	011721.20	288
18	.1695	2-1/8	3-1/4	011718.20	288
16	.1770	2-3/16	3-3/8	011716.20	288
10	.1935	2-7/16	3-5/8	011710.20	288
7	.2010	2-7/16	3-5/8	011707.20	288
3	.2130	2-1/2	3-3/4	011703.20	288
1	.2280	2-5/8	3-7/8	011701.20	288

T3C

Packaging: Tube

Size	Decimal Equivalent	Flute Length	Overall Length	Stock#	Pkg Qty
A	.2340	2-5/8	3-7/8	011901	12
B	.2380	2-3/4	4	011902	12
C	.2420	2-3/4	4	011903	12
D	.2460	2-3/4	4	011904	12
E	.2500	2-3/4	4	011905	12
F	.2570	2-7/8	4-1/8	011906	12
G	.2610	2-7/8	4-1/8	011907	12
H	.2660	2-7/8	4-1/8	011908	12
I	.2720	2-7/8	4-1/8	011909	12
J	.2770	2-7/8	4-1/8	011910	12
K	.2810	2-15/16	4-1/4	011911	12
L	.2900	2-15/16	4-1/4	011912	12
M	.2950	3-1/16	4-3/8	011913	12
N	.3020	3-1/16	4-3/8	011914	12
O	.3160	3-3/16	4-1/2	011915	6
P	.3230	3-5/16	4-5/8	011916	6
Q	.3320	3-7/16	4-3/4	011917	6
R	.3390	3-7/16	4-3/4	011918	6
S	.3480	3-1/2	4-7/8	011919	6
T	.3580	3-1/2	4-7/8	011920	6
U	.3680	3-5/8	5	011921	6
V	.3770	3-5/8	5	011922	6
W	.3860	3-3/4	5-1/8	011923	6
X	.3970	3-3/4	5-1/8	011924	6
Y	.4040	3-7/8	5-1/4	011925	6
Z	.4130	3-7/8	5-1/4	011926	6

Works Best in This Material

	Heavy-Duty Cobalt Bronze Oxide
Iron, Cast	✓
Steel, Low and Medium Carbon	✓
Steel, High Alloy	✓
Steel, Stainless and PH	✓
Tough, Medium and High-Tensile Strength Alloys	✓

• Jobber Drill

• Broca, serie corta

• Foret court



Point: 118° Point
 Material: High Speed Steel
 Coating/Finish: Bright Finish
 Other: Left Handed



T1L, Left Handed Drill

Packaging: Tube

Corresponding Set

Size	Decimal Equivalent	Flute Length	Overall Length	Stock#	Pkg Qty
1/16	.0625	7/8	1-7/8	011104	12
5/64	.0781	1	2	011105	12
3/32	.0938	1-1/4	2-1/4	011106	12
7/64	.1094	1-1/2	2-5/8	011107	12
1/8	.1250	1-5/8	2-3/4	011108	12
9/64	.1406	1-3/4	2-7/8	011109	12
5/32	.1562	2	3-1/8	011110	12
11/64	.1719	2-1/8	3-1/4	011111	12
3/16	.1875	2-5/16	3-1/2	011112	12
13/64	.2031	2-7/16	3-5/8	011113	12
7/32	.2188	2-1/2	3-3/4	011114	12
15/64	.2344	2-5/8	3-7/8	011115	12
1/4	.2500	2-3/4	4	011116	12
17/64	.2656	2-7/8	4-1/8	011117	12
9/32	.2812	2-15/16	4-1/4	011118	12
19/64	.2969	3-1/16	4-3/8	011119	12
5/16	.3125	3-3/16	4-1/2	011120	6
21/64	.3281	3-5/16	4-5/8	011121	6
11/32	.3438	3-7/16	4-3/4	011122	6
23/64	.3594	3-1/2	4-7/8	011123	6
3/8	.3750	3-5/8	5	011124	6
25/64	.3906	3-3/4	5-1/8	011125	6
13/32	.4062	3-7/8	5-1/4	011126	6
27/64	.4219	3-15/16	5-3/8	011127	6
7/16	.4375	4-1/16	5-1/2	011128	6
29/64	.4531	4-3/16	5-5/8	011129	6
15/32	.4688	4-5/16	5-3/4	011130	6
31/64	.4844	4-3/8	5-7/8	011131	6
1/2	.5000	4-1/2	6	011132	6

Style	Description	# of Pieces	Size Range	Stock#
T17L	Metal Index	29 Piece	1/16"-1/2" by 64ths	011199



Left-handed drill bits can be used to drill out broken bolts.

• Screw Machine Drill

• Broca extra corta

• Foret extra-court



Point: 135° Split Point
 Material: High Speed Steel
 Coating/Finish: Black Oxide
 Other: Heavy-Duty Construction

T4

Packaging: Tube

Size	Decimal Equivalent	Flute Length	Overall Length	Stock#	Pkg Qty
3/64*	.0469	1/2	1-3/8	044403	12
1/16	.0625	5/8	1-5/8	044404	12
5/64	.0781	11/16	1-11/16	044405	12
3/32	.0938	3/4	1-3/4	044406	12
7/64	.1094	13/16	1-13/16	044407	12
1/8	.1250	7/8	1-7/8	044408	12
9/64	.1406	15/16	1-15/16	044409	12
5/32	.1562	1	2-1/16	044410	12
11/64	.1719	1-1/16	2-1/8	044411	12
3/16	.1875	1-1/8	2-3/16	044412	12
13/64	.2031	1-3/16	2-1/4	044413	12
7/32	.2188	1-1/4	2-3/8	044414	12
15/64	.2344	1-5/16	2-7/16	044415	12
1/4	.2500	1-3/8	2-1/2	044416	12
17/64	.2656	1-7/16	2-5/8	044417	12
9/32	.2812	1-1/2	2-11/16	044418	12
19/64	.2969	1-9/16	2-3/4	044419	12
5/16	.3125	1-5/8	2-13/16	044420	6
21/64	.3281	1-11/16	2-15/16	044421	6
11/32	.3438	1-11/16	3	044422	6
23/64	.3594	1-3/4	3-1/16	044423	6
3/8	.3750	1-13/16	3-1/8	044424	6
25/64	.3906	1-7/8	3-1/4	044425	6
13/32	.4062	1-15/16	3-5/16	044426	6
27/64	.4219	2	3-3/8	044427	6
7/16	.4375	2-1/16	3-7/16	044428	6
29/64	.4531	2-1/8	3-9/16	044429	6
15/32	.4688	2-1/8	3-5/8	044430	6
31/64	.4844	2-3/16	3-11/16	044431	6
1/2	.5000	2-1/4	3-3/4	044432	6

*Size 3/64 - Conventional 135° Point

T4

Packaging: Bulk Master Pack

Size	Decimal Equivalent	Flute Length	Overall Length	Stock#	Pkg Qty
1/8	.1250	7/8	1-7/8	044408.20	144
9/64	.1406	15/16	1-15/16	044409.20	144
5/32	.1562	1	2-1/16	044410.20	144
3/16	.1875	1-1/8	2-3/16	044412.20	144
13/64	.2031	1-3/16	2-1/4	044413.20	144



Corresponding Set

Style	Description	# of Pieces	Size Range	Stock#
T29	Metal Index	29 Piece	1/16"-1/2" by 64ths	090569

T5

Packaging: Tube

Size	Decimal Equivalent	Flute Length	Overall Length	Stock#	Pkg Qty
60*	.0400	1/2	1-3/8	044560	12
59*	.0410	1/2	1-3/8	044559	12
58*	.0420	1/2	1-3/8	044558	12
57*	.0430	1/2	1-3/8	044557	12
56*	.0465	1/2	1-3/8	044556	12
55*	.0520	5/8	1-5/8	044555	12
54*	.0550	5/8	1-5/8	044554	12
53*	.0595	5/8	1-5/8	044553	12
52	.0635	11/16	1-11/16	044552	12
51	.0670	11/16	1-11/16	044551	12
50	.0700	11/16	1-11/16	044550	12
49	.0730	11/16	1-11/16	044549	12
48	.0760	11/16	1-11/16	044548	12
47	.0785	11/16	1-11/16	044547	12
46	.0810	3/4	1-3/4	044546	12
45	.0820	3/4	1-3/4	044545	12
44	.0860	3/4	1-3/4	044544	12
43	.0890	3/4	1-3/4	044543	12
42	.0935	3/4	1-3/4	044542	12
41	.0960	13/16	1-13/16	044541	12
40	.0980	13/16	1-13/16	044540	12
39	.0995	13/16	1-13/16	044539	12
38	.1015	13/16	1-13/16	044538	12
37	.1040	13/16	1-13/16	044537	12
36	.1065	13/16	1-13/16	044536	12
35	.1100	7/8	1-7/8	044535	12
34	.1110	7/8	1-7/8	044534	12
33	.1130	7/8	1-7/8	044533	12
32	.1160	7/8	1-7/8	044532	12
31	.1200	7/8	1-7/8	044531	12
30	.1285	15/16	1-15/16	044530	12
29	.1360	15/16	1-15/16	044529	12
28	.1405	15/16	1-15/16	044528	12
27	.1440	1	2-1/16	044527	12
26	.1470	1	2-1/16	044526	12
25	.1495	1	2-1/16	044525	12
24	.1520	1	2-1/16	044524	12
23	.1540	1	2-1/16	044523	12
22	.1570	1-1/16	2-1/8	044522	12
21	.1590	1-1/16	2-1/8	044521	12
20	.1610	1-1/16	2-1/8	044520	12
19	.1660	1-1/16	2-1/8	044519	12
18	.1695	1-1/16	2-1/8	044518	12
17	.1730	1-1/8	2-3/16	044517	12
16	.1770	1-1/8	2-3/16	044516	12
15	.1800	1-1/8	2-3/16	044515	12
14	.1820	1-1/8	2-3/16	044514	12
13	.1850	1-1/8	2-3/16	044513	12
12	.1890	1-3/16	2-1/4	044512	12
11	.1910	1-3/16	2-1/4	044511	12
10	.1935	1-3/16	2-1/4	044510	12
9	.1960	1-3/16	2-1/4	044509	12
8	.1990	1-3/16	2-1/4	044508	12
7	.2010	1-3/16	2-1/4	044507	12
6	.2040	1-1/4	2-3/8	044506	12
5	.2055	1-1/4	2-3/8	044505	12
4	.2090	1-1/4	2-3/8	044504	12
3	.2130	1-1/4	2-3/8	044503	12
2	.2210	1-5/16	2-7/16	044502	12
1	.2280	1-5/16	2-7/16	044501	12

Size 60 - 53 - Conventional*135° Point

T5

Packaging: Bulk Master Pack

Size	Decimal Equivalent	Flute Length	Overall Length	Stock#	Pkg Qty
60	.0400	1/2	1-3/8	044560.20	72



• Screw Machine Drill

• Broca extra corta

• Foret extra-court



Point: 135° Split Point
 Material: Premium Grade, High Speed Steel
 Coating/Finish: Black and Bronze Oxide
 Other: Heavy-Duty Construction



Point: 135° Split Point
 Material: Cobalt
 Coating/Finish: Bronze Oxide
 Other: Heavy-Duty Construction

T4HD

Packaging: Tube

Size	Decimal Equivalent	Flute Length	Overall Length	Stock#	Pkg Qty
1/16	.0625	5/8	1-5/8	060404	12
5/64	.0781	11/16	1-11/16	060405	12
3/32	.0938	3/4	1-3/4	060406	12
7/64	.1094	13/16	1-13/16	060407	12
1/8	.1250	7/8	1-7/8	060408	12
9/64	.1406	15/16	1-15/16	060409	12
5/32	.1562	1	2-1/16	060410	12
11/64	.1719	1-1/16	2-1/8	060411	12
3/16	.1875	1-1/8	2-3/16	060412	12
13/64	.2031	1-3/16	2-1/4	060413	12
7/32	.2188	1-1/4	2-3/8	060414	12
15/64	.2344	1-5/16	2-7/16	060415	12
1/4	.2500	1-3/8	2-1/2	060416	12
17/64	.2656	1-7/16	2-5/8	060417	12
9/32	.2812	1-1/2	2-11/16	060418	12
19/64	.2969	1-9/16	2-3/4	060419	12
5/16	.3125	1-5/8	2-13/16	060420	6
21/64	.3281	1-11/16	2-15/16	060421	6
11/32	.3438	1-11/16	3	060422	6
23/64	.3594	1-3/4	3-1/16	060423	6
3/8	.3750	1-13/16	3-1/8	060424	6
25/64	.3906	1-7/8	3-1/4	060425	6
13/32	.4062	1-15/16	3-5/16	060426	6
27/64	.4219	2	3-3/8	060427	6
7/16	.4375	2-1/16	3-7/16	060428	6
29/64	.4531	2-1/8	3-9/16	060429	6
15/32	.4688	2-1/8	3-5/8	060430	6
31/64	.4844	2-3/16	3-11/16	060431	6
1/2	.5000	2-1/4	3-3/4	060432	6

T4C

Packaging: Tube

Size	Decimal Equivalent	Flute Length	Overall Length	Stock#	Pkg Qty
1/16	.0625	5/8	1-5/8	046604	12
5/64	.0781	11/16	1-11/16	046605	12
3/32	.0938	3/4	1-3/4	046606	12
7/64	.1094	13/16	1-13/16	046607	12
1/8	.1250	7/8	1-7/8	046608	12
9/64	.1406	15/16	1-15/16	046609	12
5/32	.1562	1	2-1/16	046610	12
11/64	.1719	1-1/16	2-1/8	046611	12
3/16	.1875	1-1/8	2-3/16	046612	12
13/64	.2031	1-3/16	2-1/4	046613	12
7/32	.2188	1-1/4	2-3/8	046614	12
15/64	.2344	1-5/16	2-7/16	046615	12
1/4	.2500	1-3/8	2-1/2	046616	12
17/64	.2656	1-7/16	2-5/8	046617	12
9/32	.2812	1-1/2	2-11/16	046618	12
19/64	.2969	1-9/16	2-3/4	046619	12
5/16	.3125	1-5/8	2-13/16	046620	6
21/64	.3281	1-11/16	2-15/16	046621	6
11/32	.3438	1-11/16	3	046622	6
23/64	.3594	1-3/4	3-1/16	046623	6
3/8	.3750	1-13/16	3-1/8	046624	6
25/64	.3906	1-7/8	3-1/4	046625	6
13/32	.4062	1-15/16	3-5/16	046626	6
27/64	.4219	2	3-3/8	046627	6
7/16	.4375	2-1/16	3-7/16	046628	6
29/64	.4531	2-1/8	3-9/16	046629	6
15/32	.4688	2-1/8	3-5/8	046630	6
31/64	.4844	2-3/16	3-11/16	046631	6
1/2	.5000	2-1/4	3/3/2004	046632	6

T4HD

Packaging: Bulk Master Pack

Size	Decimal Equivalent	Flute Length	Overall Length	Stock#	Pkg Qty
1/8	.1250	7/8	1-7/8	060408.20	288
5/32	.1562	1	2-1/16	060410.20	288
3/16	.1875	1-1/8	2-3/16	060412.20	288
7/32	.2188	1-1/4	2-3/8	060414.20	288
1/4	.2500	1-3/8	2-1/2	060416.20	288
9/32	.2812	1-1/2	2-11/16	060418.20	72
5/16	.3125	1-5/8	2-13/16	060420.20	72

Works Best in This Material	Heavy-Duty Cobalt Bronze Oxide
Iron, Cast	✓
Steel, Low and Medium Carbon	✓
Steel, High Alloy	✓
Steel, Stainless and PH	✓
Tough, Medium and High-Tensile Strength Alloys	✓

Corresponding Set

Style	Description	# of Pieces	Size Range	Stock#
T29HD	Metal Index	29 Piece	1/16"-1/2" by 64ths	090568



• Aircraft Extension Drill

• Broca extralarga para la industria Aeronáutica

• Foret aéronautique à queue cylindrique rallongée



Point: 135° Split Point
 Material: High Speed Steel
 Coating/Finish: Black Oxide
 Other: 6" Aircraft Extension, Heavy-Duty Construction

T6HH

Packaging: Tube

T6HH Size	Decimal Equivalent	Flute Length	Overall Length	Stock#	Pkg Qty
7/64	.1094	1-1/2	6	057507	6
1/8	.1250	1-5/8	6	057508	6
9/64	.1406	1-3/4	6	057509	6
5/32	.1562	2	6	057510	6
11/64	.1719	2-1/8	6	057511	6
3/16	.1875	2-5/16	6	057512	6
13/64	.2031	2-7/16	6	057513	6
7/32	.2188	2-1/2	6	057514	6
15/64	.2344	2-5/8	6	057515	6
1/4	.2500	2-3/4	6	057516	6
17/64	.2656	2-7/8	6	057517	6
9/32	.2812	2-15/16	6	057518	6
19/64	.2969	3-1/16	6	057519	6
5/16	.3125	3-3/16	6	057520	6
21/64	.3281	3-5/16	6	057521	6
11/32	.3438	3-7/16	6	057522	6
23/64	.3594	3-1/2	6	057523	6
3/8	.3750	3-5/8	6	057524	6
7/16	.4375	4-1/16	6	057528	6
1/2	.5000	4-1/2	6	057532	6

T6WW

Packaging: Tube

Size	Decimal Equivalent	Flute Length	Overall Length	Stock#	Pkg Qty
40	.0980	1-3/8	6	057640	6
33	.1130	1-1/2	6	057633	6
30	.1285	1-5/8	6	057630	6
29	.1360	1-3/4	6	057629	6
27	.1440	1-7/8	6	057627	6
25	.1495	1-7/8	6	057625	6
21	.1590	2-1/8	6	057621	6
20	.1610	2-1/8	6	057620	6
19	.1660	2-1/8	6	057619	6
18	.1695	2-1/8	6	057618	6
11	.1910	2-5/16	6	057611	6
10	.1935	2-7/16	6	057610	6
9	.1960	2-7/16	6	057609	6
6	.2040	2-1/2	6	057606	6
5	.2055	2-1/2	6	057605	6
2	.2210	2-5/8	6	057602	6

T6WW

Packaging: Bulk Master Pack

Size	Decimal Equivalent	Flute Length	Overall Length	Stock#	Pkg Qty
20	.1610	2-1/8	6	057620.20	144
21	.1590	2-1/8	6	057621.20	144
30	.1285	1-5/8	6	057630.20	144
40	.0980	1-3/8	6	057640.20	144

T6HH

Packaging: Bulk Master Pack

Size	Decimal Equivalent	Flute Length	Overall Length	Stock#	Pkg Qty
1/16	.0625	7/8	6	057504.20	144
5/64	.0781	1	6	057505.20	144
3/32	.0938	1-1/4	6	057506.20	144
7/64	.1094	1-1/2	6	057507.20	144
1/8	.1250	1-5/8	6	057508.20	144
9/64	.1406	1-3/4	6	057509.20	144
5/32	.1562	2	6	057510.20	144
11/64	.1719	2-1/8	6	057511.20	144
3/16	.1875	2-5/16	6	057512.20	144
13/64	.2031	2-7/16	6	057513.20	144
7/32	.2188	2-1/2	6	057514.20	144
15/64	.2344	2-5/8	6	057515.20	144
1/4	.2500	2-3/4	6	057516.20	144

BP6HH

Packaging: Tube

Size	Decimal Equivalent	Flute Length	Overall Length	Stock#	Pkg Qty
1/8	.1250	1-5/8	6	057708	1
3/16	.1875	2-5/16	6	057712	1
1/4	.2500	2-3/4	6	057716	1
5/16	.3125	3-3/16	6	057720	1
3/8	.3750	3-5/8	6	057724	1
7/16	.4375	4-1/16	6	057728	1
1/2	.5000	4-1/2	6	057732	1



DRILLS

• Aircraft Extension Drill

• Broca extralarga para la industria Aeronáutica

• Foret aéronautique à queue cylindrique rallongée

• Extra Length Drill

• Broca serie extra large



Point: 135° Split Point
 Material: High Speed Steel
 Coating/Finish: Black Oxide
 Other: 12" Aircraft Extension, Heavy-Duty Construction



Point: 118° Point
 Material: High Speed Steel
 Coating/Finish: Bright Finish
 Other: General Purpose

T12HH

Packaging: Tube

Size	Decimal Equivalent	Flute Length	Overall Length	Stock#	Pkg Qty
5/64	.0781	1	12	058505	6
3/32	.0938	1-1/4	12	058506	6
7/64	.1094	1-1/2	12	058507	6
1/8	.1250	1-5/8	12	058508	6
9/64	.1406	1-3/4	12	058509	6
5/32	.1562	2	12	058510	6
11/64	.1719	2-1/8	12	058511	6
3/16	.1875	2-5/16	12	058512	6
7/32	.2188	2-1/2	12	058514	6
1/4	.2500	2-3/4	12	058516	6
17/64	.2656	2-7/8	12	058517	6
9/32	.2812	2-15/16	12	058518	6
19/64	.2969	3-1/16	12	058519	6
5/16	.3125	3-3/16	12	058520	3
11/32	.3438	3-7/16	12	058522	3
3/8	.3750	3-5/8	12	058524	3
13/32	.4062	3-7/8	12	058526	3
7/16	.4375	4-1/16	12	058528	3
15/32	.4688	4-5/16	12	058530	3
1/2	.5000	4-1/2	12	058532	3

T1290

Packaging: Tube

Size	Decimal Equivalent	Flute Length	Overall Length	Stock#	Pkg Qty
1/8	.1250	9	12	059808	1
5/32	.1562	9	12	059810	1
3/16	.2031	9	12	059812	1
7/32	.2188	9	12	059814	1
1/4	.2500	9	12	059816	1
9/32	.2812	9	12	059818	1
5/16	.3125	9	12	059820	1
11/32	.3438	9	12	059822	1
3/8	.3750	9	12	059824	1
13/32	.4062	9	12	059826	1
7/16	.4375	9	12	059828	1
15/32	.4688	9	12	059830	1
1/2	.5000	9	12	059832	1
17/32*	.5312	9	12	059834	1
9/16*	.5625	9	12	059836	1
5/8*	.6250	9	12	059840	1

* Black oxide

BP12HH

Packaging: Tube

Size	Decimal Equivalent	Flute Length	Overall Length	Stock#	Pkg Qty
1/8	.1250	1-5/8	12	058408	1
3/16	.1875	2-5/16	12	058412	1
1/4	.2500	2-3/4	12	058416	1
5/16	.3125	3-3/16	12	058420	1
3/8	.3750	3-5/8	12	058424	1
7/16	.4375	4-1/16	12	058428	1
1/2	.5000	4-1/2	12	058432	1

T1813

Packaging: Tube

Size	Decimal Equivalent	Flute Length	Overall Length	Stock#	Pkg Qty
1/4	.2500	13	18	059916	1
5/16	.3125	13	18	059920	1
3/8	.3750	13	18	059924	1
7/16	.4375	13	18	059928	1
1/2	.5000	13	18	059932	1
9/16*	.6250	13	18	059936	1
5/8*	.6250	13	18	059940	1

* Black oxide

T12WW

Packaging: Tube

Size	Decimal Equivalent	Flute Length	Overall Length	Stock#	Pkg Qty
1	.2280	2-5/8	12	058601	6
7	.2010	2-7/16	12	058607	6
10	.1935	2-7/16	12	058610	6
11	.1910	2-5/16	12	058611	6
17	.1730	2-3/16	12	058617	6
20	.1610	2-1/8	12	058620	6
30	.1285	1-5/8	12	058630	6
40	.0980	1-3/8	12	058640	6



Find the Best Drill for Your Job . . . Page 7

• Reduced Shank Drill

• Brocas de mango cilindrico

• Foret queue degagee



Point: 118° Split Point, 1/2" Shank
 Material: Premium Grade High Speed Steel
 Coating/Finish: Black and Bronze Oxide
 Other: Silver & Deming, High Performance, 3 Flats on Shank



Point: 118° Point, 1/2" Shank
 Material: Premium High Speed Steel
 Coating/Finish: Black Oxide Flutes
 Other: Silver & Deming 3 Flats on Shank

T9FHD

Packaging: Tube

Size	Decimal Equivalent	Flute Length	Overall Length	Stock#	Pkg Qty
33/64	.5156	3	6	094133	1
17/32	.5312	3	6	094134	1
35/64	.5469	3	6	094135	1
9/16	.5625	3	6	094136	1
37/64	.5781	3	6	094137	1
19/32	.5938	3	6	094138	1
39/64	.6094	3	6	094139	1
5/8	.6250	3	6	094140	1
41/64	.6406	3	6	094141	1
21/32	.6562	3	6	094142	1
43/64	.6719	3	6	094143	1
11/16	.6875	3	6	094144	1
45/64	.7031	3	6	094145	1
23/32	.7188	3	6	094146	1
47/64	.7344	3	6	094147	1
3/4	.7500	3	6	094148	1
49/64	.7656	3	6	094149	1
25/32	.7812	3	6	094150	1
51/64	.7969	3	6	094151	1
13/16	.8125	3	6	094152	1
53/64	.8281	3	6	094153	1
27/32	.8438	3	6	094154	1
55/64	.8594	3	6	094155	1
7/8	.8750	3	6	094156	1
57/64	.8906	3	6	094157	1
29/32	.9062	3	6	094158	1
59/64	.9219	3	6	094159	1
15/16	.9375	3	6	094160	1
61/64	.9531	3	6	094161	1
31/32	.9688	3	6	094162	1
63/64	.9844	3	6	094163	1
1"	1.0000	3	6	094164	1

T9F

Packaging: Tube

Size	Decimal Equivalent	Flute Length	Overall Length	Stock#	Pkg Qty
33/64	.5156	3	6	092833	1
17/32	.5312	3	6	092834	1
35/64	.5469	3	6	092835	1
9/16	.5625	3	6	092836	1
37/64	.5781	3	6	092837	1
19/32	.5938	3	6	092838	1
39/64	.6094	3	6	092839	1
5/8	.6250	3	6	092840	1
41/64	.6406	3	6	092841	1
21/32	.6562	3	6	092842	1
43/64	.6719	3	6	092843	1
11/16	.6875	3	6	092844	1
45/64	.7031	3	6	092845	1
23/32	.7188	3	6	092846	1
47/64	.7344	3	6	092847	1
3/4	.7500	3	6	092848	1
49/64	.7656	3	6	092849	1
25/32	.7812	3	6	092850	1
51/64	.7969	3	6	092851	1
13/16	.8125	3	6	092852	1
53/64	.8281	3	6	092853	1
27/32	.8438	3	6	092854	1
55/64	.8594	3	6	092855	1
7/8	.8750	3	6	092856	1
57/64	.8906	3	6	092857	1
29/32	.9062	3	6	092858	1
59/64	.9219	3	6	092859	1
15/16	.9375	3	6	092860	1
61/64	.9531	3	6	092861	1
31/32	.9688	3	6	092862	1
63/64	.9844	3	6	092863	1
1"	1.0000	3	6	092864	1
1-1/32	1.0312	3	6	092866	1
1-1/16	1.0625	3	6	092868	1
1-3/32	1.0938	3	6	092870	1
1-1/8	1.1250	3	6	092872	1
1-5/32	1.1562	3	6	092874	1
1-3/16	1.1875	3	6	092876	1
1-7/32	1.2188	3	6	092878	1
1-1/4	1.2500	3	6	092880	1
1-5/16	1.3125	3	6	092884	1
1-3/8	1.3750	3	6	092888	1
1-7/16	1.4375	3	6	092892	1
1-1/2	1.5000	3	6	092896	1



Corresponding Sets

Style	Description	# of Pieces	Size Range	Stock#
T98F	Molded Case	8 Piece	9/16"-1" by 16ths	090596
T98FHD	Molded Case	8 Piece	9/16"-1" by 16ths	090595
T933FHD	Metal Stand	33 Piece	1/2"-1" by 64ths	090593



• Reduced Shank Drill

• Brocas de mango cilindrico

• Foret queue degaage



Point: 118° Point, 1/2" Round Shank
 Material: Premium High Speed Steel
 Coating/Finish: Black Oxide Flutes
 Other: Silver & Deming

T9

Packaging: Tube

Size	Decimal Equivalent	Flute Length	Overall Length	Stock#	Pkg Qty
33/64	.5156	3	6	091733	1
17/32	.5312	3	6	091734	1
35/64	.5469	3	6	091735	1
9/16	.5625	3	6	091736	1
37/64	.5781	3	6	091737	1
19/32	.5938	3	6	091738	1
39/64	.6094	3	6	091739	1
5/8	.6250	3	6	091740	1
41/64	.6406	3	6	091741	1
21/32	.6562	3	6	091742	1
43/64	.6719	3	6	091743	1
11/16	.6875	3	6	091744	1
45/64	.7031	3	6	091745	1
23/32	.7188	3	6	091746	1
47/64	.7344	3	6	091747	1
3/4	.7500	3	6	091748	1
49/64	.7656	3	6	091749	1
25/32	.7812	3	6	091750	1
51/64	.7969	3	6	091751	1
13/16	.8125	3	6	091752	1
53/64	.8281	3	6	091753	1
27/32	.8438	3	6	091754	1
55/64	.8594	3	6	091755	1
7/8	.8750	3	6	091756	1
57/64	.8906	3	6	091757	1
29/32	.9062	3	6	091758	1
59/64	.9219	3	6	091759	1
15/16	.9375	3	6	091760	1
61/64	.9531	3	6	091761	1
31/32	.9688	3	6	091762	1
63/64	.9844	3	6	091763	1
1"	1.0000	3	6	091764	1
1-1/64	1.0156	3	6	091765	1
1-1/32	1.0312	3	6	091766	1
1-3/64	1.0469	3	6	091767	1
1-1/16	1.0625	3	6	091768	1
1-3/32	1.0938	3	6	091770	1
1-1/8	1.1250	3	6	091772	1
1-5/32	1.1562	3	6	091774	1
1-3/16	1.1875	3	6	091776	1
1-7/32	1.2188	3	6	091778	1
1-1/4	1.2500	3	6	091780	1
1-9/32	1.2812	3	6	091782	1
1-5/16	1.3125	3	6	091784	1
1-3/8	1.3750	3	6	091788	1
1-7/16	1.4375	3	6	091792	1
1-1/2	1.5000	3	6	091796	1

T9

Packaging: Bulk Master Pack

Size	Decimal Equivalent	Flute Length	Overall Length	Stock#	Pkg Qty
33/64	.5156	3	6	091733.20	25
17/32	.5312	3	6	091734.20	25
35/64	.5469	3	6	091735.20	25
9/16	.5625	3	6	091736.20	25
37/64	.5781	3	6	091737.20	25
19/32	.5938	3	6	091738.20	25
39/64	.6094	3	6	091739.20	25
5/8	.6250	3	6	091740.20	25
41/64	.6406	3	6	091741.20	25
21/32	.6562	3	6	091742.20	25
43/64	.6719	3	6	091743.20	25
11/16	.6875	3	6	091744.20	25
45/64	.7031	3	6	091745.20	25
23/32	.7188	3	6	091746.20	25
47/64	.7344	3	6	091747.20	25
3/4	.7500	3	6	091748.20	25
49/64	.7656	3	6	091749.20	25
25/32	.7812	3	6	091750.20	25
51/64	.7969	3	6	091751.20	25
13/16	.8125	3	6	091752.20	25
27/32	.8438	3	6	091754.20	25
7/8	.8750	3	6	091756.20	25
29/32	.9062	3	6	091758.20	25
15/16	.9375	3	6	091760.20	25
31/32	.9688	3	6	091762.20	25
1"	1.0000	3	6	091764.20	25
1-1/32	1.0312	3	6	091766.20	25
1-1/16	1.0625	3	6	091768.20	25
1-1/8	1.1250	3	6	091772.20	25



Corresponding Sets

Style	Description	# of Pieces	Size Range	Stock#
T98	Molded Case	8 Piece,	9/16"-1" by 16ths	090598
T933	Metal Stand	33 Piece,	1/2"-1" by 64ths	090599

• Reduced Shank Drill



Point: 118° Split Point, 1/2" Reduced Shank
 Material: Premium High Speed Steel, Cobalt
 Coating/Finish: Black and Bronze Oxide
 Other: Silver & Deming

• Brocas de mango cilindrico



Point: 135° Split Point, 3/8" Reduced Shank
 Material: Premium High Speed Steel
 Coating/Finish: Black and Bronze Oxide
 Other: Heavy-Duty Construction

• Foret queue degagee



T9C

Packaging: Tube

Size	Decimal Equivalent	Flute Length	Overall Length	Stock#	Pkg Qty
33/64	.5156	3	6	092033	1
17/32	.5312	3	6	092034	1
35/64	.5469	3	6	092035	1
9/16	.5625	3	6	092036	1
37/64	.5781	3	6	092037	1
19/32	.5938	3	6	092038	1
39/64	.6094	3	6	092039	1
5/8	.6250	3	6	092040	1
41/64	.6406	3	6	092041	1
21/32	.6562	3	6	092042	1
43/64	.6719	3	6	092043	1
11/16	.6875	3	6	092044	1
45/64	.7031	3	6	092045	1
23/32	.7188	3	6	092046	1
47/64	.7344	3	6	092047	1
3/4	.7500	3	6	092048	1
49/64	.7656	3	6	092049	1
25/32	.7812	3	6	092050	1
51/64	.7969	3	6	092051	1
13/16	.8125	3	6	092052	1
53/64	.8281	3	6	092053	1
27/32	.8438	3	6	092054	1
55/64	.8594	3	6	092055	1
7/8	.8750	3	6	092056	1
57/64	.8906	3	6	092057	1
29/32	.9062	3	6	092058	1
59/64	.9219	3	6	092059	1
15/16	.9375	3	6	092060	1
61/64	.9531	3	6	092061	1
31/32	.9688	3	6	092062	1
63/64	.9844	3	6	092063	1
1"	1.0000	3	6	092064	1

T8HD

Packaging: Tube

Size	Decimal Equivalent	Flute Length	Overall Length	Stock#	Pkg Qty
25/64	.3906	3-3/4	5-1/8	092125	6
13/32	.4062	3-7/8	5-1/4	092126	6
27/64	.4219	3-15/16	5-3/8	092127	6
7/16	.4375	4-1/16	5-1/2	092128	6
29/64	.4531	4-3/16	5-5/8	092129	6
15/32	.4688	4-5/16	5-3/4	092130	6
31/64	.4844	4-3/8	5-7/8	092131	6
1/2	.5000	4-1/2	6	092132	6

BP8HD

Packaging: Tube

Size	Decimal Equivalent	Flute Length	Overall Length	Stock#	Pkg Qty
25/64	.3906	3-3/4	5-1/8	095125	1
13/32	.4062	3-7/8	5-1/4	095126	1
27/64	.4219	3-15/16	5-3/8	095127	1
7/16	.4375	4-1/16	5-1/2	095128	1
29/64	.4531	4-3/16	5-5/8	095129	1
15/32	.4688	4-5/16	5-3/4	095130	1
31/64	.4844	4-3/8	5-7/8	095131	1
1/2	.5000	4-1/2	6	095132	1

Corresponding Sets



Style	Description	# of Pieces	Size Range	Stock#
T98C	Molded Case	8 Piece,	9/16"-1" by 16ths	090909

Corresponding Sets



Style	Description	# of Pieces	Size Range	Stock#
T815HD	Metal Index	15 Piece,	1/16"-1/2" by 32nds	099104
T829HD	Metal Index	29 Piece,	1/16"-1/2" by 64ths	099101

• **Reduced Shank Drill**



Point: 118° Point, 1/4" Reduced Shank, Economy Length
 Material: High Speed Steel
 Coating/Finish: Bright Finish
 Other: Light to intermediate duty applications

BP7

Packaging: Tube

Size	Decimal Equivalent	Flute Length	Overall Length	Stock#	Pkg Qty
5/16	.3125	2-1/4	4	091670	1
3/8	.3750	2-1/4	4	091674	1
7/16	.4375	2-1/4	4	091678	1
1/2	.5000	2-1/4	4	091682	1



Point: 118° Split Point, 1/4" Reduced Shank, Intermediate Length
 Material: High Speed Steel
 Coating/Finish: Bright Finish
 Other: Light to intermediate duty applications

BP10

Packaging: Tube

Size	Decimal Equivalent	Flute Length	Overall Length	Stock#	Pkg Qty
5/16	.3125	2-1/2	3-13/16	091640	1
3/8	.3750	2-7/8	4-1/4	091644	1
7/16	.4375	3-3/8	4-11/16	091648	1
1/2	.5000	3-5/8	5-1/16	091652	1

• **Brocas de mango cilindrico**



Point: 118° Point, 3/8" Reduced Shank
 Material: High Speed Steel
 Coating/Finish: Bright Finish
 Other: Light to intermediate duty applications

T8

Packaging: Tube

Size	Decimal Equivalent	Flute Length	Overall Length	Stock#	Pkg Qty
25/64	.3906	3-3/4	5-1/8	091825	6
13/32	.4062	3-7/8	5-1/4	091826	6
27/64	.4219	3-15/16	5-3/8	091827	6
7/16	.4375	4-1/16	5-1/2	091828	6
29/64	.4531	4-3/16	5-5/8	091829	6
15/32	.4688	4-5/16	5-3/4	091830	6
31/64	.4844	4-3/8	5-7/8	091831	6
1/2	.5000	4-1/2	6	091832	6

BP8

Packaging: Tube

Size	Decimal Equivalent	Flute Length	Overall Length	Stock#	Pkg Qty
7/16	.4375	4-1/16	5-1/2	091928	1
1/2	.5000	4-1/2	6	091932	1



Corresponding Sets (For styles T8, BP8)

Style	Description	# of Pieces	Size Range	Stock#
T815	Metal Index	15 Piece	1/16"-1/2" by 32nds	090815
T829	Metal Index	29 Piece	1/16"-1/2" by 64ths	090829



Find the Best Drill for Your Job . . . Page 7

• Solid Carbide Burs

• Lima Rotativa

• Burin au Carbure Solide

Point: Double Cut
 Material: Solid Carbide
 Coating/Finish: Bright Finish
 Packaging: Tube
 Other: Produces smooth finish for general purpose applications



SA (Cylinder)

Style	Cutting Diameter	Length of Cut	Stock #	Pkg Qty
SA-1	1/4"	5/8	071423	1
SA-3	3/8"	3/4	071424	1
SA-5	1/2"	1	071425	1
SA-7	3/4"	1	071426	1



SB (Cylinder with End Cut)

Style	Cutting Diameter	Length of Cut	Stock #	Pkg Qty
SB-1	1/4"	5/8	071427	1
SB-3	3/8"	3/4	071428	1
SB-5	1/2"	1	071429	1
SB-7	3/4"	1	071430	1



SC (Cylinder with Radius, Ball Nose)

Style	Cutting Diameter	Length of Cut	Stock #	Pkg Qty
SC-1	1/4"	5/8	071433	1
SC-3	3/8"	3/4	071434	1
SC-5	1/2"	1	071435	1
SC-6	5/8"	1	071436	1



SD (Ball)

Style	Cutting Diameter	Length of Cut	Stock #	Pkg Qty
SD-1	1/4"	1/4	071439	1
SD-3	3/8"	3/8	071440	1
SD-5	1/2"	1/2	071441	1



SE (Oval)

Style	Cutting Diameter	Length of Cut	Stock #	Pkg Qty
SE-1	1/4"	3/8	071443	1
SE-3	3/8"	5/8	071444	1
SE-5	1/2"	7/8	071445	1
SE-6	5/8"	1	071446	1



SF (Tree with Radius)

Style	Cutting Diameter	Length of Cut	Stock #	Pkg Qty
SF-1	1/4"	5/8	071449	1
SF-3	3/8"	3/4	071450	1
SF-5	1/2"	1	071451	1
SF-6	5/8"	1	071452	1



SG (Tree Shape)

Style	Cutting Diameter	Length of Cut	Stock #	Pkg Qty
SG-1	1/4"	5/8	071455	1
SG-3	3/8"	3/4	071456	1
SG-5	1/2"	1	071457	1



SH (Flame)

Style	Cutting Diameter	Length of Cut	Stock #	Pkg Qty
SH-1	1/4"	1/2	071459	1
SH-5	1/2"	1-1/4	071460	1



SJ (60° Cone)

Style	Cutting Diameter	Length of Cut	Stock #	Pkg Qty
SJ-1	1/4"	3/16	071462	1
SJ-3	3/8"	1/4	071463	1
SJ-5	1/2"	7/16	071464	1



Recommended Applications:

Brass, Bronze, Copper, Cast Iron, Steel 40-55 Rc, Steel 55-60 Rc, Steel, Nickel, Chrome Stainless Steel, Steel Weldments, Titanium

SPECIAL PURPOSE

continued on next page

• **Solid Carbide Burs**
See description on page 36

• Lima Rotativa

• Burin au Carbure Solide



SK (90° Cone)

Style	Cutting Diameter	Length of Cut	Stock #	Pkg Qty
SK-1	1/4"	1/8	071466	1
SK-3	3/8"	3/16	071467	1
SK-5	1/2"	1/4	071468	1



SL (14° Taper with Radius)

Style	Cutting Diameter	Length of Cut	Stock #	Pkg Qty
SL-1	1/4"	5/8	071470	1
SL-3	3/8"	1-1/16	071471	1
SL-4	1/2"	1-1/8	071472	1
SL-5	5/8"	1-3/16	071473	1
SL-7	3/4"	1-1/2	071474	1



SM (Cone)

Style	Cutting Diameter	Length of Cut	Stock #	Pkg Qty
SM-2	1/4"	3/4	071477	1
SM-4	3/8"	5/8	071478	1
SM-5	1/2"	7/8	071479	1



SN (Inverted Cone)

Style	Cutting Diameter	Length of Cut	Stock #	Pkg Qty
SN-1	1/4"	5/16	071481	1
SN-2	3/8"	3/8	071482	1
SN-4	1/2"	1/2	071483	1

Corresponding Sets



Plastic Case - 9 Piece	Stock #
BUR 14 SET, 1/4" Cut, 1/4" Shank SA-1, SC-1, SD-1, SE-1, SF-1, SG-1, SH-1, SL-1, SM-2	071485
BUR 38 SET, 3/8" Cut, 1/4" Shank SA-3, SC-3, SD-3, SE-3, SF-3, SG-3, SH-1, SL-3, SM-4	071487
BUR 12 SET, 1/2" Cut, 1/4" Shank SA-5, SC-5, SD-5, SE-5, SF-5, SG-5, SH-5, SL-4, SM-5	071488



Miniature Double Cut, 1/8" Shank

Style	Cutting Diameter	Length of Cut	Stock #	Pkg Qty
SA-51	1/4"	1/2	071421	1
SC-51	1/4"	1/2	071431	1
SD-51	1/4"	7/32	071437	1
SE-51	1/4"	3/8	071442	1
SF-51	1/4"	1/2	071447	1
SG-51	1/4"	1/2	071453	1
SM-51	1/4"	1/2	071475	1

Miniature 1-1/2" Overall Length

Style	Cutting Diameter	Length of Cut	Stock #	Pkg Qty
SA-43	1/8"	9/16	071422	1
SC-42	1/8"	9/16	071432	1
SD-42	1/8"	1/8	071438	1
SE-41	1/8"	7/32	071484	1
SF-42	1/8"	1/2	071448	1
SG-43	1/8"	3/8	071454	1
SH-41	1/8"	1/4	071458	1
SJ-42	1/8"	3/32	071461	1
SK-42	1/8"	1/16	071465	1
SL-42	1/8"	1/2	071469	1
SM-42	1/8"	7/16	071476	1
SN-42	1/8"	3/16	071480	1

Miniature Corresponding Set



Plastic Case - 9 Piece	Stock #
BUR 18 SET, 1/8" Cut, 1/8" Shank SA-43, SC-42, SD-42, SE-41, SF-42, SG-43, SH-41, SL-42, SN-42	071486



Recommended Applications:

Brass, Bronze, Copper, Cast Iron, Steel 40-55 Rc, Steel 55-60 Rc, Steel, Nickel, Chrome Stainless Steel, Steel Weldments, Titanium

SPECIAL PURPOSE

• **Annular Cutters**

• **Cortador Anular**

• **Couteau Annulaire**

• **Annular Cutter Machines**

• **Couteau Annulaire pour machine**

• **Taladro Electromagnetico**



Material: Cobalt High Speed Steel
 Coating/Finish: Bright Finish
 Other: Chipbreaker Tooth Design



Annular Cutter Machines	Stock#
Cutter Capacity 1-3/8", Drill Capacity 1/2", Height 15", Weight 28 lbs	087553
Cutter Capacity 2", Drill Capacity 3/4", Height 15.5", Weight 40 lbs	087554
Cutter Capacity 4", Drill Capacity 1-1/2", Height 21", Weight 57 lbs	087555

TAC

Packaging: Tube

Cutter Diamer	1" Depth of Cut Stock #	2" Depth of Cut Stock #	Pkg Qty
7/16	087501	087527	1
1/2	087502	087528	1
9/16	087503	087529	1
5/8	087504	087530	1
11/16	087505	087531	1
3/4	087506	087532	1
13/16	087507	087533	1
7/8	087508	087534	1
15/16	087509	087535	1
1"	087510	087536	1
1-1/16	087511	087537	1
1-1/8	087512	087538	1
1-3/16	087513	087539	1
1-1/4	087514	087540	1
1-5/16	087515	087541	1
1-3/8	087516	087542	1
1-7/16	087517	087543	1
1-1/2	087518	087544	1
1-9/16	087519	087545	1
1-5/8	087520	087546	1
1-11/16	087521	087547	1
1-3/4	087522	087548	1
1-13/16	087523	087549	1
1-7/8	087524	087550	1
1-15/16	087525	087551	1
2"	087526	087552	1

Annular Cutter Machine Accessories	Stock#	
TAC-DRILL UP 000	1/2" chuck to annular adapter	087557
TAC-DRILL UP 001	Milling machine adapter 3/4" shank	087558
TAC-DRILL UP 002	R8 collett adapter to 3/4" shank	087559
TAC-DRILL UP 210	Standard #2 morse taper arbor	087560
TAC-DRILL UP 310	Standard #3 morse taper arbor	087561
TAC-DRILL UP 410	#4 Morse taper arbor	087562
TAC-ACC UP 101	Pipe diameter attachment	087563
TAC-ACC UP 102	500 ml Unibor coolant (1 pint)	087564
TAC-ACC UP 103	5 liter Unibor coolant (10 pints)	087565
TAC-ACC UP 106	Small machine carrying case	087566
TAC-ACC UP 107	Large machine carrying case	087567
TAC-ACC SKIT 01	Cutter kit	087568
TAC-CHUCK UP 053	1/2" Chuck and key	087569
TAC-CHUCK UP 054	5/8" chuck & key	087570
TAC-CHUCK UP252	#2 Morse taper chuck adapter	087571
TAC-CHUCK UP 253	#3 Morse taper chuck adapter for 5/8" chuck	087572
TAC-CHUCK UP 256	#3 Morse taper chuck adapter for 3/4" chuck	087573
TAC-ARB UP317	#3 Morse taper extended arbor	087574
TAC-ARB P-M0502	BD-35 replacement arbor	087575
TAC-ARB ARBOIL 2	#2 Morse taper arbor with coolant feed	087576
TAC-ARB ARBOIL 3	#3 Morse taper arbor with coolant feed	087577
TAC-ARB QH-110	EQ35 Replacement Quick-Hitch Arbor	087578
TAC-ARB QH-210	#2 Morse taper Quick Hitch Arbor	087579
TAC-ARB QH-310	#3 Morse taper Quick Hitch Arbor	087580

SPECIAL PURPOSE

• **Ejector Pilots**

• **Piloto Botador**

• **Pointes Ejecteur pour Couteau Annulaire**

Spring-loaded pilot ejects the center as a "slug"



TAC Pilots

Packaging: Tube

Description		Stock #	Pkg Qty	
For 7/16" Diameter	For 1" Depth of Cut, Short	3/16" x 3"	087499	1
	For 2" Depth of Cut, Long	3/16" x 4"	087498	1
For 1/2" Diameter and larger	For 1" Depth of Cut, Short	1/4" x 3"	087497	1
	For 2" Depth of Cut, Long	1/4" x 4"	087496	1



- Designed for cutting large diameter holes accurately, cleanly and effortlessly
- Faster feed, lower thrust, longer tool life
- Recommended for use in the building and construction market in such materials as thin sheet metal and angle iron

• Alignment Reamer

• Rima de Alineamiento

• Alesoir à Main

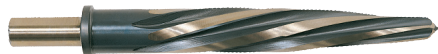

ALIGNMENT REAMER®

Point: 1/2" Shank, 3-Flatted Shank
 Material: High Speed Steel
 Coating/Finish: Black and Bronze Oxide
 Other: 3 flats on shank prevents slippage in 3-jaw chuck

TCR Packaging: Tube

Size	Decimal Equivalent	Flute Length	Overall Length	Stock#	Pkg Qty
3/8*	.3750	3"	5"	072280	1
7/16	.4375	3-1/4	5-1/4	072279	1
1/2	.5000	3-15/16	5-15/16	072281	1
9/16	.5625	3-15/16	5-15/16	072282	1
5/8	.6250	4-1/2	6-9/16	072283	1
11/16	.6875	4-1/2	6-9/16	072284	1
3/4	.7500	4-15/16	7"	072285	1
13/16	.8125	4-15/16	7"	072286	1
7/8	.8750	5-3/16	7-1/4	072287	1
15/16	.9375	5-3/16	7-1/4	072288	1
1"	1.0000	5-3/16	7-1/4	072289	1
1-1/4"	1.2500	5"	6-7/8	072291	1

*3/8" shank

Corresponding Set

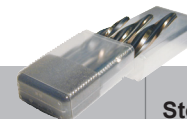

Style	Description	Size Range	Stock #
TCR3	Resealable Plastic Tube	3 Piece, 1/2", 5/8", 3/4"	072290

SPECIAL PURPOSE

• Hole Saw Pilot Drill

• Broca Piloto

• Foret Pour Scie Annulaires



Point: 135° Self-Centering Split Point
 Material: High Speed Steel
 Coating/Finish: Bright Finish
 Other: 3 flats on shank prevents slippage in drill chuck

PD3F

Packaging: Tube

Size	Decimal Equivalent	Flute Length	Overall Length	Stock#	Pkg Qty
1/4	.2500	1-3/8	4-1/4	093216	12

PD3F

Packaging: Bulk Master Pack

Size	Decimal Equivalent	Flute Length	Overall Length	Stock#	Pkg Qty
1/4	.2500	1-3/8	4-1/4	093216.20	288



Find the Best Drill for Your Job . . . Page 7

• Body Drill

• Broca Hojalatero

• Foret Pour Carrosserie



Point: 135° Split Point, Double End
 Material: High Speed Steel
 Coating/Finish: Black Oxide
 Other: Recommended use in thin sheet metal. Popular for pop-rivet drilling applications

TSM8 Packaging: Tube

Size	Decimal Equivalent	Flute Length	Overall Length	Stock#	Pkg Qty
7/64	.1094	1/2	1-7/8	098807	12
1/8	.1250	1/2	2	098808	12
9/64	.1406	1/2	2	098809	12
5/32	.1562	1/2	2-1/16	098810	12
3/16	.1875	1/2	2-3/16	098812	12
7/32	.2188	1/2	2-3/8	098814	12
1/4	.2500	1/2	2-1/2	098816	12
11	.1910	1/2	2-1/4	098811	12
20	.1610	1/2	2-1/8	098820	12
30	.1285	1/2	2	098830	12

TSM8 Packaging: Bulk Master Pack

Size	Decimal Equivalent	Flute Length	Overall Length	Stock#	Pkg Qty
1/8	.1250	1/2	2	098808.20	288
9/64	.1406	1/2	2	098809.20	288
3/16	.1875	1/2	2-3/16	098812.20	288
1/4	.2500	1/2	2-1/2	098816.20	288
30	.1285	1/2	2	098830.20	288

SPECIAL PURPOSE

• Quick Change Chuck

• Broquero Cambio Rapido

• Mandarin à Changement Rapide



Material: Rust-Resistant Black Oxide
 Other: Installs in 3/8" or larger chucks. Positive locking feature holds 1/4" hex shank drills and screw driver bits in place when withdrawing from working materials

TQCCI

Packaging: Tube

Description	Stock #
3-Flats, Rust-Resistant Black Oxide	99200



Find the Best Drill for Your Job . . . Page 7

• Center Reamer/
Countersink

• Avellanador

• Outils à chambre

• Hex Shank
Drill

• Broca Zanco
Hexagonal

• Forets à Queue
Hexagone



Point: 82° Point
Material: High Speed Steel
Coating/Finish: Black Oxide
Other: Used for countersinking screw heads



Point: 135° Self-Centering Split Point
Material: High Speed Steel
Coating/Finish: Black Oxide
Other: 1/4" hex shank for hex or adjustable power tool chucks. Recommended use in hard wood, soft wood, plywood, particle board, plastic, metal

T401

Packaging: Tube

Size	Shank Diameter	Overall Length	Stock#	Pkg Qty
1/4	3/16	1-1/2	039416	1
3/8	1/4	1-3/4	039417	1
1/2	3/8	2	039418	1
5/8	3/8	2-1/4	039419	1
3/4	1/2	2-5/8	039420	1
1"	1/2	3	039464	1

HEXT4

Packaging: Tube

Size	Decimal Equivalent	Flute Length	Overall Length	Stock#	Pkg Qty
1/16	.0625	5/8	2-1/4	045404	1
3/32	.0938	3/4	2-7/16	045406	1
1/8	.1250	7/8	2-5/8	045408	1
5/32	.1562	1	2-13/16	045410	1
3/16	.1875	1-1/8	3	045412	1
7/32	.2188	1-1/4	3-1/8	045414	1
1/4	.2500	1-3/8	3-3/16	045416	1

HEXT4

Packaging: Bulk Master Pack

Size	Decimal Equivalent	Flute Length	Overall Length	Stock#	Pkg Qty
3/32	.0938	3/4	2-7/16	045406.20	72
1/8	.1250	7/8	2-5/8	045408.20	72
5/32	.1562	1	2-13/16	045410.20	72
3/16	.1875	1-1/8	3	045412.20	72
1/4	.2500	1-3/8	3-3/16	045416.20	72



Corresponding Set

Style	Description	# of Pieces	Size Range	Stock #
T47HEX	Plastic Case	7 Piece	1/16"-1/4" by 32nds	045432

SPECIAL PURPOSE



Find the Best Drill for
Your Job . . . Page 7



How to Tap Effectively

Successful tapping includes selecting the proper tap for the application. Consideration must be given to:

- The material to be tapped
- The material hardness
- Whether the hole is a through hole or a blind hole
- The depth or length of thread
- The percentage of thread

Tapping Geometry

- **Straight Flute Taps** contain most of the chip in the flutes, and can be used for through or blind holes.
- **Spiral Point Taps** push the chips forward, and are recommended for through holes.
- **Taper Taps** are used for starting threads in tougher materials.
- **Bottoming Taps** are used for blind holes to obtain the maximum length of thread.
- **Plug Taps** are suitable for either through or blind holes, where ample clearance remains between the thread the the bottom of the hole.

Tap Set Section starting on page 43



Tap Troubleshooting Guide

Trouble	Possible Cause	Correction
Oversize Pitch Diameter	Incorrect tap	<ul style="list-style-type: none"> • Use correct "H" limit • Use longer chamfered tap
	Chip packing	<ul style="list-style-type: none"> • Use spiral pointed tap • Use larger drill size • Shorten length of thread in blind holes
	Galling	<ul style="list-style-type: none"> • Reduce tapping speed • Use lubricants
Torn or Rough Threads	Dull tap Chamfer too short	<ul style="list-style-type: none"> • Resharpener or replace • Increase chamfer length
	Galling	<ul style="list-style-type: none"> • Use lubricant • Reduce speed • Use larger drill
Breakage	Incorrect tap selection	<ul style="list-style-type: none"> • Increase chamfer length • Use spiral pointed taps in through holes • Tapping too deep
	Excessive tapping torque	<ul style="list-style-type: none"> • Increase hole size • Shorten thread length • Increase chamfer length
	Operating conditions	<ul style="list-style-type: none"> • Reduce tapping speed • Avoid bottoming out the tap
Chipping	Incorrect tap selection	<ul style="list-style-type: none"> • Increase chamfer length • Avoid chip packing in flutes
	Operating conditions	<ul style="list-style-type: none"> • Reduce tapping speed • Use larger drill • Ensure adequate lubricant
Excessive Wear	Incorrect tap selection	<ul style="list-style-type: none"> • Increase chamfer length
	Operating conditions	<ul style="list-style-type: none"> • Reduce tapping speed • Ensure adequate lubricant • Use larger drill



Straight flute taps can be used in through or blind holes

• Straight Flute Hand Tap

• Machos de mano

• Tarauds a main



Material: High Speed Steel
 Size: Machine Screw
 Coating/Finish: Bronze Oxide
 Chamfer: Taper (7-10 threads long); Plug (3-5 threads long)
 Bottoming (1-2 threads long)



Size	Pkg. Qty.	Thread Limit	# of Flutes	Drill Size	T62HDT Taper	T62HDP Plug	T62HDB Bottoming
4-40 NC	12	H2	3	43	071040	071090	071140
6-32 NC	12	H3	3	36	071041	071091	071141
6-40 NF	12	H2	3	33	071042	071092	071142
8-32 NC	12	H3	4	29	071043	071093	071143
8-36 NF	12	H2	4	29	071044	071094	071144
10-24 NC	12	H3	4	25	071045	071095	071145
10-32 NF	12	H3	4	21	071046	071096	071146
12-24 NC	12	H3	4	16	071047	071097	071147
12-28 NF	12	H3	4	15	071048	071098	071148

Packaging: Snap Pack



Material: High Speed Steel
 Size: Fractional
 Coating/Finish: Bronze Oxide
 Chamfer: Taper (7-10 threads long); Plug (3-5 threads long)
 Bottoming (1-2 threads long)



Size	Pkg. Qty.	Thread Limit	# of Flutes	Drill Size	T61HDT Taper	T61HDP Plug	T61HDB Bottoming
1/4-20 NC	6	H3	4	7	071000	071060	071100
1/4-28 NF	6	H3	4	3	071001	071061	071101
5/16-18 NC	6	H3	4	F	071002	071062	071102
5/16-24 NF	6	H3	4	I	071003	071063	071103
3/8-16 NC	6	H3	4	5/16	071004	071064	071104
3/8-24 NF	6	H3	4	Q	071005	071065	071105
7/16-14 NC	3	H3	4	U	071006	071066	071106
7/16-20 NF	3	H3	4	25/64	071007	071067	071107
1/2-13 NC	3	H3	4	27/64	071008	071068	071108
1/2-20 NF	3	H3	4	29/64	071009	071069	071109
9/16-12 NC	1	H3	4	31/64	071010	071070	071110
9/16-18 NF	1	H3	4	33/64	071011	071071	071111
5/8-11 NC	1	H3	4	17/32	071012	071072	071112
5/8-18 NF	1	H3	4	37/64	071013	071073	071113
3/4-10 NC	1	H3	4	21/32	071014	071074	071114
3/4-16 NF	1	H3	4	11/16	071015	071075	071115
7/8-9 NC	1	H3	4	49/64	071016	071076	071116
7/8-14 NF	1	H3	4	13/16	071017	071077	071117
1-8 NC	1	H3	4	7/8	071018	071078	071118
1-12 NF	1	H3	4	59/64	071019	071079	071119
1-1/8-7 NC	1	H3	4	63/64	071020	071080	071120

Packaging: 1/4-20 through 1/2-20 = Snap Pack; 9/16-1/2 through 1-1/8-7 = Tube

NC = National Course NF = National Fine
 NS = National Special NPT = National Pipe Thread

TAPS & DIES



• Straight Flute Hand Tap

• Machos de mano

• Tarauds a main



Material: High Speed Steel
 Size: Machine Screw
 Coating/Finish: Bronze Oxide
 Chamfer: Taper (7-10 threads long); Plug (3-5 threads long)
 Bottoming (1-2 threads long)



Size	Pkg. Qty.	Thread Limit	# of Flutes	Drill Size	BP62HDT Taper	BP62HDP Plug	BP62HDB Bottoming
4-40 NC	1	H2	3	43	071350	071360	071370
6-32 NC	1	H3	3	36	071351	071361	071371
6-40 NF	1	H3	3	33	071352	071362	071372
8-32 NC	1	H3	4	29	071353	071363	071373
8-36 NF	1	H3	4	29	071354	071364	071374
10-24 NC	1	H3	4	25	071355	071365	071375
10-32 NF	1	H3	4	21	071356	071366	071376
12-24 NC	1	H3	4	16	071357	071367	071377
12-28 NF	1	H3	4	15	071358	071368	071378

Packaging: Tube

TAPS & DIES



Material: High Speed Steel
 Size: Fractional
 Coating/Finish: Bronze Oxide
 Chamfer: Taper (7-10 threads long); Plug (3-5 threads long)
 Bottoming (1-2 threads long)



Size	Pkg. Qty.	Thread Limit	# of Flutes	Drill Size	BP61HDT Taper	BP61HDP Plug	BP61HDB Bottoming
1/4-20 NC	1	H3	4	7	071300	071315	071330
1/4-28 NF	1	H3	4	3	071301	071316	071331
5/16-18 NC	1	H3	4	F	071302	071317	071332
5/16-24 NF	1	H3	4	I	071303	071318	071333
3/8-16 NC	1	H3	4	5/16	071304	071319	071334
3/8-24 NF	1	H3	4	Q	071305	071320	071335
7/16-14 NC	1	H3	4	U	071306	071321	071336
7/16-20 NF	1	H3	4	25/64	071307	071322	071337
1/2-13 NC	1	H3	4	27/64	071308	071323	071338
1/2-20 NF	1	H3	4	29/64	071309	071324	071339

Packaging: Tube

NC = National Course NF = National Fine
 NS = National Special NPT = National Pipe Thread



Straight flute taps can be used in through or blind holes

• Spiral Point Tap

• Machos de maquina

• Tarauds machine

THUNDERTAP®



Material: High Speed Steel
Size: Machine Screw
Coating/Finish: Bronze Oxide
Chamfer: Plug (3-5 threads long)

Size	Pkg. Qty.	Thread Limit	# of Flutes	Drill Size	T64HD Plug
4-40 NC	12	H2	2	43	071230
6-32 NC	12	H3	2	36	071231
8-32 NC	12	H3	2	29	071232
10-24 NC	12	H3	2	25	071233
10-32 NF	12	H3	2	21	071234
12-24 NC	12	H3	2	16	071235

Packaging: Snap Pack

Material: High Speed Steel
Size: Fractional
Coating/Finish: Bronze Oxide
Chamfer: Plug (3-5 threads long)

Size	Pkg. Qty.	Thread Limit	# of Flutes	Drill Size	T63HD Plug
1/4-20 NC	6	H3	2	7	071200
1/4-28 NF	6	H3	2	3	071201
5/16-18 NC	6	H3	2	F	071202
5/16-24 NF	6	H3	2	I	071203
3/8-16 N6	6	H3	3	5/16	071204
3/8-24 NF	3	H3	3	Q	071205
7/16-14 NC	3	H3	3	U	071206
7/16-20 NF	3	H3	3	25/64	071207
1/2-13 NC	3	H3	3	27/64	071208
1/2-20 NF	3	H3	3	29/64	071209

Packaging: Snap Pack

NC = National Course NF = National Fine
NS = National Special NPT = National Pipe Thread



Spiral point taps are recommended for through holes

• Spiral Point Tap

• Machos de maquina

• Tarauds machine

THUNDER TAP®



Material: High Speed Steel
 Size: Machine Screw
 Coating/Finish: Bronze Oxide
 Chamfer: Plug (3-5 threads long)

Size	Pkg. Qty.	Thread Limit	# of Flutes	Drill Size	BP64HD Plug
4-40 NC	1	H2	2	43	071415
6-32 NC	1	H3	2	36	071416
8-32 NC	1	H3	2	29	071417
10-24 NC	1	H3	2	25	071418
10-32 NF	1	H3	2	21	071419
12-24 NC	1	H3	2	16	071420

Packaging: Tube

Material: High Speed Steel
 Size: Fractional
 Coating/Finish: Bronze Oxide
 Chamfer: Plug (3-5 threads long)

Size	Pkg. Qty.	Thread Limit	# of Flutes	Drill Size	BP63HD Plug
1/4-20 NC	1	H3	2	7	071400
1/4-28 NF	1	H3	2	3	071401
5/16-18 NC	1	H3	2	F	071402
5/16-24 NF	1	H3	2	I	071403
3/8-16 NC	1	H3	3	5/16	071404
3/8-24 NF	1	H3	3	Q	071405
7/16-14 NC	1	H3	3	U	071406
7/16-20 NF	1	H3	3	25/64	071407
1/2-13 NC	1	H3	3	27/64	071408
1/2-20 NF	1	H3	3	29/64	071409

Packaging: Tube

Corresponding ThunderTap Sets

T66HDSET THUNDER TAP®

3 Piece, Fractional
 Packaging: Plastic Case
 (1) each Taper, Plug, Bottom Tap

Size	Stock#
1/4-20 NC	071600
1/4-28 NF	071601
5/16-18 NC	071602
5/16-24 NF	071603
3/8-16 NC	071604
3/8-24 NF	071605
7/16-14 NC	071606
7/16-20 NF	071607
1/2-13 NC	071608
1/2-20 NF	071609
9/16-12 NC	071610
9/16-18 NF	071611
5/8-11 NC	071612
5/8-18 NF	071613
3/4-10 NC	071614
3/4-16 NF	071615
7/8-9 NC	071616
7/8-14 NF	071617
1-8 NC	071618
1-12 NF	071619



TAPS & DIES

NC = National Course NF = National Fine
 NS = National Special NPT = National Pipe Thread



Spiral point taps are recommended for through holes

• Taper Pipe Tap

• Machos de maquina

• Tarauds machine

THUNDERTAP®



Material: High Speed Steel
 Size: Fractional
 Coating/Finish: Bronze Oxide
 Chamfer: Taper (7-10 threads long)

Size	Pkg. Qty.	# of Flutes	Drill Size	T65HD Taper
1/8-27 NPT	1	4	R	071250
1/4-18 NPT	1	4	7/16	071251
3/8-18 NPT	1	4	37/64	071252
1/2-14 NPT	1	4	45/64	071253
3/4 -14 NPT	1	5	59/64	071254
1-11-1/2 NPT	1	5	1-5/32	071255
1-1/4-11-1/2 NPT	1	5	1-1/2	071256
1-1/2-11-1/2 NPT	1	7	1-47/64	071257

Packaging: Tube

TAPS & DIES

NC = National Course NF = National Fine
 NS = National Special NPT = National Pipe Thread



Look for this icon for more tap and other helpful information

DRILL SETS

Jobber.....	49-50
Screw Machine.....	49
Mechanic's Length	50
Reduced Shank.....	50



SPECIAL PURPOSE SETS

ThunderBit®/ThunderTap® Combination Set.....	50
---	----

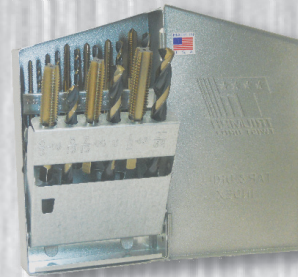

Solid Carbide Bur Sets.....	36
-----------------------------	----



METAL DISPLAYS

51

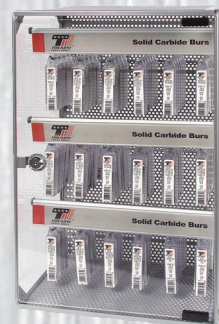

TAP SETS

51





• Drill Sets

• Juego de Brocas, serie corta

• Coffret de forest courts

Jobber, Fractional (Metal Index)	Stock #
13 Piece, 1/16"– 1/4" by 64ths	
T19 General Purpose, Bright Finish	090519
T19B General Purpose, Black Oxide	099814
T19D Heavy-Duty, Black Oxide	099815
T19C Cobalt, Bronze Oxide	099823
T19HD ThunderBit®, Black & Bronze Oxide	099858
T19HDC ThunderBit®, Cobalt, HSS	099813

15 Piece, 1/16"– 1/2" by 32nds	
T18 General Purpose, Bright Finish	090518
T18B General Purpose, Black Oxide	099808
T18D Heavy-Duty, Black Oxide	099809
T18C Cobalt, Bronze Oxide	099826
T18HD ThunderBit®, Black & Bronze Oxide	099857
T18HDC ThunderBit®, Cobalt, HSS	099816

21 Piece, 1/16"– 3/8" by 64ths	
T180 General Purpose, Bright Finish	090580
T180B General Purpose, Black Oxide	099835
T180D Heavy-Duty, Black Oxide	099836
T180C Cobalt, Bronze Oxide	099825
T180HD ThunderBit®, Black & Bronze Oxide	099861
T180HDC ThunderBit®, Cobalt, HSS	099819

29 Piece, 1/16"– 1/2" by 64ths	
T17 General Purpose, Bright Finish	090517
T17L General Purpose, L.H., Bright Finish	011199
T17B General Purpose, Black Oxide	099802
T17D Heavy-Duty, Black Oxide	099803
T17C Cobalt, Bronze Oxide	099822
T17HD ThunderBit®, Black & Bronze Oxide	099856
T17HDC ThunderBit®, Cobalt, HSS	099821
T17HDCDC , CLIP-ON INDEX ThunderBit®, Cobalt, HSS	099854
T17HDDC , CLIP-ON INDEX ThunderBit®, Black & Bronze Oxide	099855
T17HDG ThunderBit®, TIN Coated	093700

Jobber, Wire (Metal Index)	Stock #
T22 60 Piece, HSS, General Purpose, Bright Finish, #1-#60	090522
T22B 60 Piece, HSS, General Purpose, Black Oxide, #1-#60	099820
T22HD 60 Piece, ThunderBit®, Black & Bronze Oxide, #1-#60	099859
T23 20 Piece, HSS, General Purpose, Bright Finish, #61-#80	090523

Jobber, Letter (Metal Index)	Stock #
26 Piece, A-Z	
T25B General Purpose, Black Oxide	099827
T25HD ThunderBit®, Black & Bronze Oxide	099860

Jobber (Metal Index)	Stock #
Metric	
MM19HD, 1mm-10mm x .5 ThunderBit®, Black & Bronze Oxide	099866
MM25HD, 1mm-13mm x .5 ThunderBit®, Black & Bronze Oxide	099867

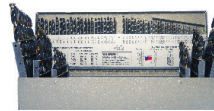

Jobber, Combination Sizes (Metal Index)	Stock #
115 Piece, 1/16 - 1/2 by 64ths, #1-#60, A-Z	
T123 115 Piece, General Purpose, Bright Finish	090560
T123B 115 Piece, General Purpose, Black Oxide	099832
T123D 115 Piece, Heavy-Duty, Black Oxide	090561
T123C 115 Piece, Cobalt, Bronze Oxide	099831
T123HD 115 Piece, ThunderBit®, Black & Bronze Oxide	099862

Jobber, Miscellaneous	Stock #
Select-A-Drill Case	
SAD13 13 Piece, General Purpose, Bright Finish, 1/16 - 1/4 by 64ths	090490
SAD13HD 13 Piece, ThunderBit®, Black & Bronze Oxide, 1/16 - 1/4 by 64ths	090495
SAD21 21 Piece, General Purpose, Bright Finish, 1/16 - 3/8 by 64ths	090491
SAD21HD 21 Piece, ThunderBit®, Black & Bronze Oxide, 1/16 - 3/8" by 64ths	090496
Metal Index	
T14P 14 Piece, General Purpose, Bright Finish, 1/16, 5/64, 3/32, 7/64, 1/8, 9/64, 5/32, 3/16, 7/32, 1/4, 5/16, 3/8, 7/16, 1/2. Sizes over 1/4" have 1/4" reduced shank; in plastic case.	090614



Screw Machine (Metal Index)	Stock #
Fractional	
T29 29 Piece, Heavy-Duty, Black Oxide, 1/16 - 1/2 by 64ths	090569
T29HD 29 Piece, Black & Bronze Oxide, 1/16 - 1/2 by 64ths	090568



- Drill Sets
- Juego de Brocas, serie corta
- Coffret de forest courts
- Special Purpose Sets
- Serie cortas
- Courts

Jobber Length, MRO Plus®, Black/Bronze Oxide	Stock #
T1019D 13 Piece - Fractional 1/16 - 1/4 by 64ths	090113
T1018D 15 Piece - Fractional 1/16 - 1/2 by 32nds	090115
T10180D 21 Piece - Fractional 1/16 - 3/8 by 64ths	090121
T10125D 26 Piece - Letter 1/16 - 1/2 by 64ths	099828
T1017D 29 Piece - Fractional 1/16 - 1/2 by 64ths	090190
T1017DC CLIP-ON INDEX 29 Piece - Fractional 1/16 - 1/2 by 64ths	090192
T10123D 115 Piece, Fractional, Wire, Letter 1/16 - 1/2" by 64ths; #1-#60; A-Z	090196



Mechanic's Length (Metal Index)	Stock #
T19M 13 Piece, Black & Bronze Oxide 1/16 - 1/4 by 64ths	090547
T18M 15 Piece, Black & Bronze Oxide 1/16 - 1/2 by 32nds	090551
T180M 21 Piece, Black & Bronze Oxide 1/16 - 3/8 by 64ths	090549
T17M 29 Piece, Black & Bronze Oxide 1/16 - 1/2 by 64ths	090552
T829M 29 Piece, Black & Bronze Oxide 1/16 - 1/2 by 64ths (3/8" Shank)	090550
T17MDC CLIP-ON INDEX 29 Piece, Black & Bronze Oxide 1/16 - 1/2 by 64ths	090553



Reduced Shank	Stock #
Metal Index	
T815 15 Piece, General Purpose, Bright Finish, 1/16 - 1/2 by 32nds, 3/8" Shank	090815
T815B 15 Piece, General Purpose, Black Oxide, 1/16 - 1/2 by 32nds, 3/8" Shank	099812
T815HD 15 Piece, ThunderBit®, Black & Bronze Oxide,, 1/16 - 1/2 by 32nds, 3/8" Shank	099104
T829 29 Piece, General Purpose, Bright Finish 1/16 - 1/2 by 64ths, 3/8" Shank	090829
T829B 29 Piece, General Purpose, Black Oxide 1/16 - 1/2 by 64ths, 3/8" Shank	099833
T829HD 29 Piece, ThunderBit®, Black & Bronze Oxide 1/16 - 1/2 by 64ths, 3/8" Shank	099101
Molded Plastic Case	
T98 8 Piece, Silver & Deming, Black Oxide (Round Shank), 9/16 - 1" by 16ths, 1/2" Shank	090598
T98C 8 Piece, Silver & Deming, Black & Bronze Oxide Cobalt, 9/16 - 1" by 16ths, 1/2" Shank	090909
T98F 8 Piece, Silver & Deming, Black Oxide (Flatted Shank), 9/16 - 1" by 16ths, 1/2" Shank	090596
T98FHD 8 Piece, ThunderBit®, Black & Bronze Oxide, (Flatted Shank), 9/16 - 1" by 16ths, 1/2" Shank	090595
Metal Stand	
T933 33 Piece, Silver & Deming, Black Oxide (Round Shank), 1/2 - 1" by 64ths, 1/2" Shank	090599
T933FHD 33 Piece, ThunderBit®, Black & Bronze Oxide, (Flatted Shank), 1/2 - 1" by 64ths, 1/2" Shank	090593



Hex Shank	Stock #
Plastic Case	
T47HEX 7 Piece, General Purpose, Black Oxide, 1/16 - 1/4 by 32nds	045432



Combination Set	Stock #
Metal Index	
TD18HDNC 18 Piece, Metal Index ThunderBit: 7, F, 5/16, U, 27/64, 36, 29, 25, 16 ThunderTap: 1/4-20 NC, 5/16-18 NC, 3/8-16 NC, 7/16-14 NC, 1/2-13 NC, 6-32 NC, 8-32 NC, 10-24 NC, 12-24 NC	071497

THUNDERBIT THUNDERTAP



SETS

- Metal Displays
- Exibidores de Metal
- Presentoir en Métale

Tap Sets

Counter or Wall



540 Piece, see below for sizes included (drill bits not shown)	Stock #
T80 General Purpose, Bright Finish	069980
T80HD ThunderBit®, Black & Bronze Oxide	099995
Sizes Included (1/16 - 1/2 by 64ths)	
(24) 1/16 - 7/64	(12) 17/64 - 5/16
(60) 1/8	(6) 21/64-23/64
(24) 9/64 - 11/64	(12) 3/8
(48) 3/16	(6) 25/64-27/64
(24) 13/64 - 15/64	(12) 7/16
(60) 1/4	(6) 29/64-1/2

T66HDSET



3 Piece, Fractional
Packaging: Plastic Case (1) each Taper, Plug, Bottom Tap

Size	Stock#
1/4-20 NC	071600
1/4-28 NF	071601
5/16-18 NC	071602
5/16-24 NF	071603
3/8-16 NC	071604
3/8-24 NF	071605
7/16-14 NC	071606
7/16-20 NF	071607
1/2-13 NC	071608
1/2-20 NF	071609
9/16-12 NC	071610
9/16-18 NF	071611
5/8-11 NC	071612
5/8-18 NF	071613
3/4-10 NC	071614
3/4-16 NF	071615
7/8-9 NC	071616
7/8-14 NF	071617
1-8 NC	071618
1-12 NF	071619



Counter Display



Holds 29 Piece Jobber Length Drill Bits (drill bits not included)	Stock #
T80X (14-1/4" H x 14" L x 12-3/4" Deep)	090970

Display Idea
(Solid Carbide Burs)



Counter or Wall

Tools not included

Holds a variety of tools on hooks (tools not included)	Stock #
POPR (13" W, 2' H)	090976

BUR SETS



Plastic Case - 9 Piece	Stock #
BUR 14 SET, 1/4" Cut, 1/4" Shank SA-1, SC-1, SD-1, SE-1, SF-1, SG-1, SH-1, SL-1, SM-2	071485
BUR 38 SET, 3/8" Cut, 1/4" Shank SA-3, SC-3, SD-3, SE-3, SF-3, SG-3, SH-1, SL-3, SM-4	071487
BUR 12 SET, 1/2" Cut, 1/4" Shank SA-5, SC-5, SD-5, SE-5, SF-5, SG-5, SH-5, SL-4, SM-5	071488



29 Piece
Index Shown

Metal Index

Holds Jobber Length Drills (drills not included)	Stock #
13 Piece 1/16 - 1/4 by 64ths	090919
15 Piece 1/16 - 1/2 by 32nds	090918
21 Piece 1/16 - 3/8 by 64ths	090980
29 Piece 1/16 - 1/2 by 64ths	090917
115 Piece 1/16 - 1/2 by 64ths; #1-#60, A-Z	090940

MINIATURE BUR SET

Plastic Case - 9 Piece	Stock #
BUR 18 SET, 1/8" Cut, 1/8" Shank SA-43, SC-42, SD-42, SE-41, SF-42, SG-43, SH-41, SL-42, SN-42	071486

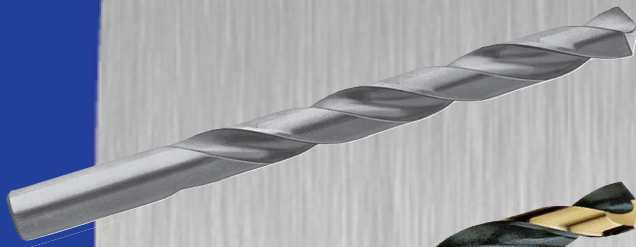

**Jobber Length, Series 801, 800
Page 53**

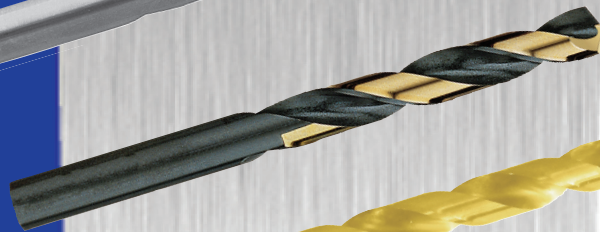

**Jobber Length, Series 807, 806
Page 54**

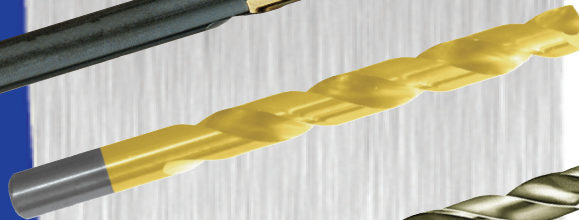

**Jobber Length, Series 803
Page 55**

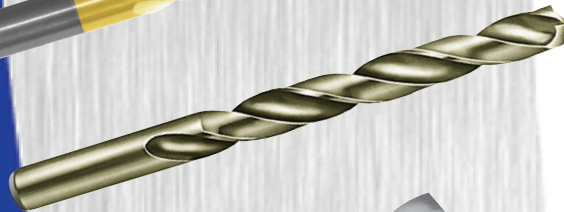

**Jobber Length, Series 805, 804
Page 56**

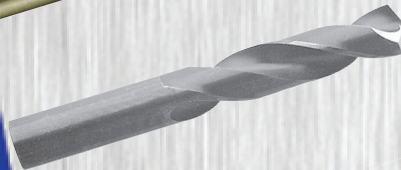

**Screw Machine Length,
Series 809, 808, Page 57**

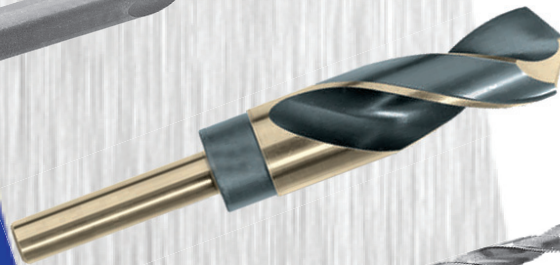

**Reduced Shank, S&D
Series 810, Page 58**

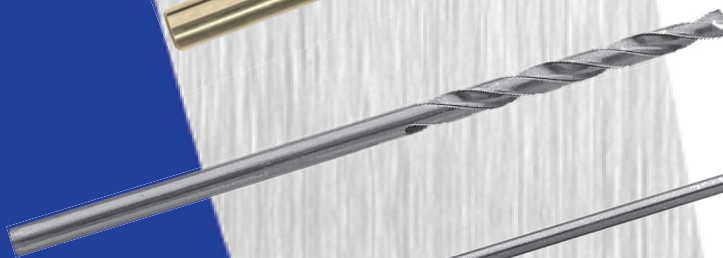

**Aircraft Extension Drill, 6"
8256, Page 59**



**Aircraft Extension Drill, 12"
82512, Page 59**



**Body Drill
831, Page 59**



**Glass & Tile Drill
860, Page 64**

**TOOLS WITH
THE POWER[®]
TO PERFORM**



• Jobber Drill

• Broca, serie corta

• Foret court



Point: 118° Point
 Material: High Speed Steel
 Coating/Finish: Black Oxide
 Other: General Purpose

801

Packaging: Tube

Size	Decimal Equivalent	Flute Length	Overall Length	Stock#	Pkg Qty
1/16	.0625	7/8	1-7/8	080103	12
5/64	.0781	1	2	080104	12
3/32	.0938	1-1/4	2-1/4	080105	12
7/64	.1094	1-1/2	2-5/8	080106	12
1/8	.1250	1-5/8	2-3/4	080107	12
9/64	.1406	1-3/4	2-7/8	080108	12
5/32	.1562	2	3-1/8	080109	12
11/64	.1719	2-1/8	3-1/4	080110	12
3/16	.1875	2-5/16	3-1/2	080111	12
13/64	.2031	2-7/16	3-5/8	080112	12
7/32	.2188	2-1/2	3-3/4	080113	12
15/64	.2344	2-5/8	3-7/8	080114	12
1/4	.2500	2-3/4	4	080115	12
17/64	.2656	2-7/8	4-1/8	080116	12
9/32	.2812	2-15/16	4-1/4	080117	12
19/64	.2969	3-1/16	4-3/8	080118	12
5/16	.3125	3-3/16	4-1/2	080119	6
21/64	.3281	3-5/16	4-5/8	080120	6
11/32	.3438	3-7/16	4-3/4	080121	6
23/64	.3594	3-1/2	4-7/8	080122	6
3/8	.3750	3-5/8	5	080123	6
25/64	.3906	3-3/4	5-1/8	080124	6
13/32	.4062	3-7/8	5-1/4	080125	6
27/64	.4219	3-15/16	5-3/8	080126	6
7/16	.4375	4-1/16	5-1/2	080127	6
29/64	.4531	4-3/16	5-5/8	080128	6
15/32	.4688	4-5/16	5-3/4	080129	6
31/64	.4844	4-3/8	5-7/8	080130	6
1/2	.5000	4-1/2	6	080131	6

800

Packaging: Tube

Size	Decimal Equivalent	Flute Length	Overall Length	Stock#	Pkg Qty
60	.0400	11/16	1-5/8	080060	12
59	.0410	11/16	1-5/8	080059	12
58	.0420	11/16	1-5/8	080058	12
57	.0430	3/4	1-3/4	080057	12
56	.0465	3/4	1-3/4	080056	12
55	.0520	7/8	1-7/8	080055	12
54	.0550	7/8	1-7/8	080054	12
53	.0595	7/8	1-7/8	080053	12
52	.0635	7/8	1-7/8	080052	12
51	.0670	1	2	080051	12
50	.0700	1	2	080050	12
49	.0730	1	2	080049	12
48	.0760	1	2	080048	12
47	.0785	1	2	080047	12
46	.0810	1-1/8	2-1/8	080046	12
45	.0820	1-1/8	2-1/8	080045	12
44	.0860	1-1/8	2-1/8	080044	12
43	.0890	1-1/4	2-1/4	080043	12
42	.0935	1-1/4	2-1/4	080042	12
41	.0960	1-3/8	2-3/8	080041	12
40	.0980	1-3/8	2-3/8	080040	12
39	.0995	1-3/8	2-3/8	080039	12
38	.1015	1-7/16	2-1/2	080038	12
37	.1040	1-7/16	2-1/2	080037	12
36	.1065	1-7/16	2-1/2	080036	12
35	.1100	1-1/2	2-5/8	080035	12
34	.1110	1-1/2	2-5/8	080034	12
33	.1130	1-1/2	2-5/8	080033	12
32	.1160	1-5/8	2-3/4	080032	12
31	.1200	1-5/8	2-3/4	080031	12
30	.1285	1-5/8	2-3/4	080030	12
29	.1360	1-3/4	2-7/8	080029	12
28	.1405	1-3/4	2-7/8	080028	12
27	.1440	1-7/8	3	080027	12
26	.1470	1-7/8	3	080026	12
25	.1495	1-7/8	3	080025	12
24	.1520	2	3-1/8	080024	12
23	.1540	2	3-1/8	080023	12
22	.1570	2	3-1/8	080022	12
21	.1590	2-1/8	3-1/4	080021	12
20	.1610	2-1/8	3-1/4	080020	12
19	.1660	2-1/8	3-1/4	080019	12
18	.1695	2-1/8	3-1/4	080018	12
17	.1730	2-3/16	3-3/8	080017	12
16	.1770	2-3/16	3-3/8	080016	12
15	.1800	2-3/16	3-3/8	080015	12
14	.1820	2-3/16	3-3/8	080014	12
13	.1850	2-5/16	3-1/2	080013	12
12	.1890	2-5/16	3-1/2	080012	12
11	.1910	2-5/16	3-1/2	080011	12
10	.1935	2-7/16	3-5/8	080010	12
9	.1960	2-7/16	3-5/8	080009	12
8	.1990	2-7/16	3-5/8	080008	12
7	.2010	2-7/16	3-5/8	080007	12
6	.2040	2-1/2	3-3/4	080006	12
5	.2055	2-1/2	3-3/4	080005	12
4	.2090	2-1/2	3-3/4	080004	12
3	.2130	2-1/2	3-3/4	080003	12
2	.2210	2-5/8	3-7/8	080002	12
1	.2280	2-5/8	3-7/8	080001	12



Black oxide finish provides added lubricity



• Jobber Drill



• Broca, serie corta

Point: 135° Split Point
 Material: High Speed Steel
 Coating/Finish: Black/Gold Oxide
 Other: Heavy Duty

• Foret court

807

Packaging: Tube

Size	Decimal Equivalent	Flute Length	Overall Length	Stock#	Pkg Qty
1/16	.0625	7/8	1-7/8	080703	12
5/64	.0781	1	2	080704	12
3/32	.0938	1-1/4	2-1/4	080705	12
7/64	.1094	1-1/2	2-5/8	080706	12
1/8	.1250	1-5/8	2-3/4	080707	12
9/64	.1406	1-3/4	2-7/8	080708	12
5/32	.1562	2	3-1/8	080709	12
11/64	.1719	2-1/8	3-1/4	080710	12
3/16	.1875	2-5/16	3-1/2	080711	12
13/64	.2031	2-7/16	3-5/8	080712	12
7/32	.2188	2-1/2	3-3/4	080713	12
15/64	.2344	2-5/8	3-7/8	080714	12
1/4	.2500	2-3/4	4	080715	12
17/64	.2656	2-7/8	4-1/8	080716	12
9/32	.2812	2-15/16	4-1/4	080717	12
19/64	.2969	3-1/16	4-3/8	080718	12
5/16	.3125	3-3/16	4-1/2	080719	6
21/64	.3281	3-5/16	4-5/8	080720	6
11/32	.3438	3-7/16	4-3/4	080721	6
23/64	.3594	3-1/2	4-7/8	080722	6
3/8	.3750	3-5/8	5	080723	6
25/64	.3906	3-3/4	5-1/8	080724	6
13/32	.4062	3-7/8	5-1/4	080725	6
27/64	.4219	3-15/16	5-3/8	080726	6
7/16	.4375	4-1/16	5-1/2	080727	6
29/64	.4531	4-3/16	5-5/8	080728	6
15/32	.4688	4-5/16	5-3/4	080729	6
31/64	.4844	4-3/8	5-7/8	080730	6
1/2	.5000	4-1/2	6	080731	6

806

Packaging: Tube

Size	Decimal Equivalent	Flute Length	Overall Length	Stock#	Pkg Qty
60	.0400	11/16	1-5/8	080660	12
59	.0410	11/16	1-5/8	080659	12
58	.0420	11/16	1-5/8	080658	12
57	.0430	3/4	1-3/4	080657	12
56	.0465	3/4	1-3/4	080656	12
55	.0520	7/8	1-7/8	080655	12
54	.0550	7/8	1-7/8	080654	12
53	.0595	7/8	1-7/8	080653	12
52	.0635	7/8	1-7/8	080652	12
51	.0670	1	2	080651	12
50	.0700	1	2	080650	12
49	.0730	1	2	080649	12
48	.0760	1	2	080648	12
47	.0785	1	2	080647	12
46	.0810	1-1/8	2-1/8	080646	12
45	.0820	1-1/8	2-1/8	080645	12
44	.0860	1-1/8	2-1/8	080644	12
43	.0890	1-1/4	2-1/4	080643	12
42	.0935	1-1/4	2-1/4	080642	12
41	.0960	1-3/8	2-3/8	080641	12
40	.0980	1-3/8	2-3/8	080640	12
39	.0995	1-3/8	2-3/8	080639	12
38	.1015	1-7/16	2-1/2	080638	12
37	.1040	1-7/16	2-1/2	080637	12
36	.1065	1-7/16	2-1/2	080636	12
35	.1100	1-1/2	2-5/8	080635	12
34	.1110	1-1/2	2-5/8	080634	12
33	.1130	1-1/2	2-5/8	080633	12
32	.1160	1-5/8	2-3/4	080632	12
31	.1200	1-5/8	2-3/4	080631	12
30	.1285	1-5/8	2-3/4	080630	12
29	.1360	1-3/4	2-7/8	080629	12
28	.1405	1-3/4	2-7/8	080628	12
27	.1440	1-7/8	3	080627	12
26	.1470	1-7/8	3	080626	12
25	.1495	1-7/8	3	080625	12
24	.1520	2	3-1/8	080624	12
23	.1540	2	3-1/8	080623	12
22	.1570	2	3-1/8	080622	12
21	.1590	2-1/8	3-1/4	080621	12
20	.1610	2-1/8	3-1/4	080620	12
19	.1660	2-1/8	3-1/4	080619	12
18	.1695	2-1/8	3-1/4	080618	12
17	.1730	2-3/16	3-3/8	080617	12
16	.1770	2-3/16	3-3/8	080616	12
15	.1800	2-3/16	3-3/8	080615	12
14	.1820	2-3/16	3-3/8	080614	12
13	.1850	2-5/16	3-1/2	080613	12
12	.1890	2-5/16	3-1/2	080612	12
11	.1910	2-5/16	3-1/2	080611	12
10	.1935	2-7/16	3-5/8	080610	12
9	.1960	2-7/16	3-5/8	080609	12
8	.1990	2-7/16	3-5/8	080608	12
7	.2010	2-7/16	3-5/8	080607	12
6	.2040	2-1/2	3-3/4	080606	12
5	.2055	2-1/2	3-3/4	080605	12
4	.2090	2-1/2	3-3/4	080604	12
3	.2130	2-1/2	3-3/4	080603	12
2	.2210	2-5/8	3-7/8	080602	12
1	.2280	2-5/8	3-7/8	080601	12

DRILLS

• Jobber Drill

• Broca, serie corta

• Foret court



Point: 135° Split Point
 Material: High Speed Steel
 Coating/Finish: TiN
 Other: Heavy-Duty Construction

803

Packaging: Tube

Size	Decimal Equivalent	Flute Length	Overall Length	Stock#	Pkg Qty
1/16	.0625	7/8	1-7/8	080303	12
5/64	.0781	1	2	080304	12
3/32	.0938	1-1/4	2-1/4	080305	12
7/64	.1094	1-1/2	2-5/8	080306	12
1/8	.1250	1-5/8	2-3/4	080307	12
9/64	.1406	1-3/4	2-7/8	080308	12
5/32	.1562	2	3-1/8	080309	12
11/64	.1719	2-1/8	3-1/4	080310	12
3/16	.1875	2-5/16	3-1/2	080311	12
13/64	.2031	2-7/16	3-5/8	080312	12
7/32	.2188	2-1/2	3-3/4	080313	12
15/64	.2344	2-5/8	3-7/8	080314	12
1/4	.2500	2-3/4	4	080315	12
17/64	.2656	2-7/8	4-1/8	080316	12
9/32	.2812	2-15/16	4-1/4	080317	12
19/64	.2969	3-1/16	4-3/8	080318	12
5/16	.3125	3-3/16	4-1/2	080319	6
21/64	.3281	3-5/16	4-5/8	080320	6
11/32	.3438	3-7/16	4-3/4	080321	6
23/64	.3594	3-1/2	4-7/8	080322	6
3/8	.3750	3-5/8	5	080323	6
25/64	.3906	3-3/4	5-1/8	080324	6
13/32	.4062	3-7/8	5-1/4	080325	6
27/64	.4219	3-15/16	5-3/8	080326	6
7/16	.4375	4-1/16	5-1/2	080327	6
29/64	.4531	4-3/16	5-5/8	080328	6
15/32	.4688	4-5/16	5-3/4	080329	6
31/64	.4844	4-3/8	5-7/8	080330	6
1/2	.5000	4-1/2	6	080331	6

• Jobber Drill



• Broca, serie corta

Point: 135° Split Point
 Material: Cobalt, High Speed Steel
 Coating/Finish: Bronze Oxide
 Other: Heavy-Duty Construction

• Foret court

805

Packaging: Tube

Size	Decimal Equivalent	Flute Length	Overall Length	Stock#	Pkg Qty
1/16	.0625	7/8	1-7/8	080503	12
5/64	.0781	1	2	080504	12
3/32	.0938	1-1/4	2-1/4	080505	12
7/64	.1094	1-1/2	2-5/8	080506	12
1/8	.1250	1-5/8	2-3/4	080507	12
9/64	.1406	1-3/4	2-7/8	080508	12
5/32	.1562	2	3-1/8	080509	12
11/64	.1719	2-1/8	3-1/4	080510	12
3/16	.1875	2-5/16	3-1/2	080511	12
13/64	.2031	2-7/16	3-5/8	080512	12
7/32	.2188	2-1/2	3-3/4	080513	12
15/64	.2344	2-5/8	3-7/8	080514	12
1/4	.2500	2-3/4	4	080515	12
17/64	.2656	2-7/8	4-1/8	080516	12
9/32	.2812	2-15/16	4-1/4	080517	12
19/64	.2969	3-1/16	4-3/8	080518	12
5/16	.3125	3-3/16	4-1/2	080519	6
21/64	.3281	3-5/16	4-5/8	080520	6
11/32	.3438	3-7/16	4-3/4	080521	6
23/64	.3594	3-1/2	4-7/8	080522	6
3/8	.3750	3-5/8	5	080523	6
25/64	.3906	3-3/4	5-1/8	080524	6
13/32	.4062	3-7/8	5-1/4	080525	6
27/64	.4219	3-15/16	5-3/8	080526	6
7/16	.4375	4-1/16	5-1/2	080527	6
29/64	.4531	4-3/16	5-5/8	080528	6
15/32	.4688	4-5/16	5-3/4	080529	6
31/64	.4844	4-3/8	5-7/8	080530	6
1/2	.5000	4-1/2	6	080531	6

804

Packaging: Tube

Size	Decimal Equivalent	Flute Length	Overall Length	Stock#	Pkg Qty
60	.0400	11/16	1-5/8	080460	12
59	.0410	11/16	1-5/8	080459	12
58	.0420	11/16	1-5/8	080458	12
57	.0430	3/4	1-3/4	080457	12
56	.0465	3/4	1-3/4	080456	12
55	.0520	7/8	1-7/8	080455	12
54	.0550	7/8	1-7/8	080454	12
53	.0595	7/8	1-7/8	080453	12
52	.0635	7/8	1-7/8	080452	12
51	.0670	1	2	080451	12
50	.0700	1	2	080450	12
49	.0730	1	2	080449	12
48	.0760	1	2	080448	12
47	.0785	1	2	080447	12
46	.0810	1-1/8	2-1/8	080446	12
45	.0820	1-1/8	2-1/8	080445	12
44	.0860	1-1/8	2-1/8	080444	12
43	.0890	1-1/4	2-1/4	080443	12
42	.0935	1-1/4	2-1/4	080442	12
41	.0960	1-3/8	2-3/8	080441	12
40	.0980	1-3/8	2-3/8	080440	12
39	.0995	1-3/8	2-3/8	080439	12
38	.1015	1-7/16	2-1/2	080438	12
37	.1040	1-7/16	2-1/2	080437	12
36	.1065	1-7/16	2-1/2	080436	12
35	.1100	1-1/2	2-5/8	080435	12
34	.1110	1-1/2	2-5/8	080434	12
33	.1130	1-1/2	2-5/8	080433	12
32	.1160	1-5/8	2-3/4	080432	12
31	.1200	1-5/8	2-3/4	080431	12
30	.1285	1-5/8	2-3/4	080430	12
29	.1360	1-3/4	2-7/8	080429	12
28	.1405	1-3/4	2-7/8	080428	12
27	.1440	1-7/8	3	080427	12
26	.1470	1-7/8	3	080426	12
25	.1495	1-7/8	3	080425	12
24	.1520	2	3-1/8	080424	12
23	.1540	2	3-1/8	080423	12
22	.1570	2	3-1/8	080422	12
21	.1590	2-1/8	3-1/4	080421	12
20	.1610	2-1/8	3-1/4	080420	12
19	.1660	2-1/8	3-1/4	080419	12
18	.1695	2-1/8	3-1/4	080418	12
17	.1730	2-3/16	3-3/8	080417	12
16	.1770	2-3/16	3-3/8	080416	12
15	.1800	2-3/16	3-3/8	080415	12
14	.1820	2-3/16	3-3/8	080414	12
13	.1850	2-5/16	3-1/2	080413	12
12	.1890	2-5/16	3-1/2	080412	12
11	.1910	2-5/16	3-1/2	080411	12
10	.1935	2-7/16	3-5/8	080410	12
9	.1960	2-7/16	3-5/8	080409	12
8	.1990	2-7/16	3-5/8	080408	12
7	.2010	2-7/16	3-5/8	080407	12
6	.2040	2-1/2	3-3/4	080406	12
5	.2055	2-1/2	3-3/4	080405	12
4	.2090	2-1/2	3-3/4	080404	12
3	.2130	2-1/2	3-3/4	080403	12
2	.2210	2-5/8	3-7/8	080402	12
1	.2280	2-5/8	3-7/8	080401	12

DRILLS



• Screw Machine Drill

• Broca extra corta

• Foret extra-court



Point: 135° Split Point
 Material: High Speed Steel
 Coating/Finish: Black Oxide
 Other: Heavy-Duty Construction

809

Packaging: Tube

Size	Decimal Equivalent	Flute Length	Overall Length	Stock#	Pkg Qty
1/16	.0625	5/8	1-5/8	080903	12
5/64	.0781	11/16	1-11/16	080904	12
3/32	.0938	3/4	1-3/4	080905	12
7/64	.1094	13/16	1-13/16	080906	12
1/8	.1250	7/8	1-7/8	080907	12
9/64	.1406	15/16	1-15/16	080908	12
5/32	.1562	1	2-1/16	080909	12
11/64	.1719	1-1/16	2-1/8	080910	12
3/16	.1875	1-1/8	2-3/16	080911	12
13/64	.2031	1-3/16	2-1/4	080912	12
7/32	.2188	1-1/4	2-3/8	080913	12
15/64	.2344	1-5/16	2-7/16	080914	12
1/4	.2500	1-3/8	2-1/2	080915	12
17/64	.2656	1-7/16	2-5/8	080916	12
9/32	.2812	1-1/2	2-11/16	080917	12
19/64	.2969	1-9/16	2-3/4	080918	12
5/16	.3125	1-5/8	2-13/16	080919	6
21/64	.3281	1-11/16	2-15/16	080920	6
11/32	.3438	1-11/16	3	080921	6
23/64	.3594	1-3/4	3-1/16	080922	6
3/8	.3750	1-13/16	3-1/8	080923	6
25/64	.3906	1-7/8	3-1/4	080924	6
13/32	.4062	1-15/16	3-5/16	080925	6
27/64	.4219	2	3-3/8	080926	6
7/16	.4375	2-1/16	3-7/16	080927	6
29/64	.4531	2-1/8	3-9/16	080928	6
15/32	.4688	2-1/8	3-5/8	080929	6
31/64	.4844	2-3/16	3-11/16	080930	6
1/2	.5000	2-1/4	3-3/4	080931	6

808

Packaging: Tube

Size	Decimal Equivalent	Flute Length	Overall Length	Stock#	Pkg Qty
60	.0400	11/16	1-5/8	080860	12
59	.0410	11/16	1-5/8	080859	12
58	.0420	11/16	1-5/8	080858	12
57	.0430	3/4	1-3/4	080857	12
56	.0465	3/4	1-3/4	080856	12
55	.0520	7/8	1-7/8	080855	12
54	.0550	7/8	1-7/8	080854	12
53	.0595	7/8	1-7/8	080853	12
52	.0635	7/8	1-7/8	080852	12
51	.0670	1	2	080851	12
50	.0700	1	2	080850	12
49	.0730	1	2	080849	12
48	.0760	1	2	080848	12
47	.0785	1	2	080847	12
46	.0810	1-1/8	2-1/8	080846	12
45	.0820	1-1/8	2-1/8	080845	12
44	.0860	1-1/8	2-1/8	080844	12
43	.0890	1-1/4	2-1/4	080843	12
42	.0935	1-1/4	2-1/4	080842	12
41	.0960	1-3/8	2-3/8	080841	12
40	.0980	1-3/8	2-3/8	080840	12
39	.0995	1-3/8	2-3/8	080839	12
38	.1015	1-7/16	2-1/2	080838	12
37	.1040	1-7/16	2-1/2	080837	12
36	.1065	1-7/16	2-1/2	080836	12
35	.1100	1-1/2	2-5/8	080835	12
34	.1110	1-1/2	2-5/8	080834	12
33	.1130	1-1/2	2-5/8	080833	12
32	.1160	1-5/8	2-3/4	080832	12
31	.1200	1-5/8	2-3/4	080831	12
30	.1285	1-5/8	2-3/4	080830	12
29	.1360	1-3/4	2-7/8	080829	12
28	.1405	1-3/4	2-7/8	080828	12
27	.1440	1-7/8	3	080827	12
26	.1470	1-7/8	3	080826	12
25	.1495	1-7/8	3	080825	12
24	.1520	2	3-1/8	080824	12
23	.1540	2	3-1/8	080823	12
22	.1570	2	3-1/8	080822	12
21	.1590	2-1/8	3-1/4	080821	12
20	.1610	2-1/8	3-1/4	080820	12
19	.1660	2-1/8	3-1/4	080819	12
18	.1695	2-1/8	3-1/4	080818	12
17	.1730	2-3/16	3-3/8	080817	12
16	.1770	2-3/16	3-3/8	080816	12
15	.1800	2-3/16	3-3/8	080815	12
14	.1820	2-3/16	3-3/8	080814	12
13	.1850	2-5/16	3-1/2	080813	12
12	.1890	2-5/16	3-1/2	080812	12
11	.1910	2-5/16	3-1/2	080811	12
10	.1935	2-7/16	3-5/8	080810	12
9	.1960	2-7/16	3-5/8	080809	12
8	.1990	2-7/16	3-5/8	080808	12
7	.2010	2-7/16	3-5/8	080807	12
6	.2040	2-1/2	3-3/4	080806	12
5	.2055	2-1/2	3-3/4	080805	12
4	.2090	2-1/2	3-3/4	080804	12
3	.2130	2-1/2	3-3/4	080803	12
2	.2210	2-5/8	3-7/8	080802	12
1	.2280	2-5/8	3-7/8	080801	12



Black oxide finish provides added lubricity



• Reduced Shank Drill

• Brocas de mango cilindrico

• Foret queue degagee

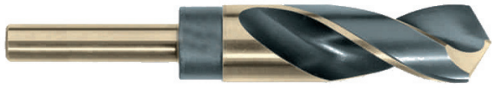

Point: 135° Split Point, 1/2" Shank
 Material: High Speed Steel
 Coating/Finish: Black/Gold Oxide
 Other: Silver & Deming
 3 Flats on Shank

810

Packaging: Tube

Size	Decimal Equivalent	Flute Length	Overall Length	Stock#	Pkg Qty
33/64	.5156	3	6	081050	1
17/32	.5312	3	6	081051	1
35/64	.5469	3	6	081052	1
9/16	.5625	3	6	081053	1
37/64	.5781	3	6	081054	1
19/32	.5938	3	6	081055	1
39/64	.6094	3	6	081056	1
5/8	.6250	3	6	081057	1
41/64	.6406	3	6	081058	1
21/32	.6562	3	6	081059	1
43/64	.6719	3	6	081060	1
11/16	.6875	3	6	081061	1
45/64	.7031	3	6	081062	1
23/32	.7188	3	6	081063	1
47/64	.7344	3	6	081064	1
3/4	.7500	3	6	081065	1
49/64	.7656	3	6	081066	1
25/32	.7812	3	6	081067	1
51/64	.7969	3	6	081068	1
13/16	.8125	3	6	081069	1
53/64	.8281	3	6	081070	1
27/32	.8438	3	6	081071	1
55/64	.8594	3	6	081072	1
7/8	.8750	3	6	081073	1
57/64	.8906	3	6	081074	1
29/32	.9062	3	6	081075	1
59/64	.9219	3	6	081076	1
15/16	.9375	3	6	081077	1
61/64	.9531	3	6	081078	1
31/32	.9688	3	6	081079	1
63/64	.9844	3	6	081080	1
1"	1.0000	3	6	081081	1
1-1/16	1.0625	3	6	081083	1
1-3/32	1.0938	3	6	081084	1
1-1/8	1.1250	3	6	081085	1
1-5/32	1.1562	3	6	081086	1
1-3/16	1.1875	3	6	081087	1
1-7/32	1.2188	3	6	081088	1
1-1/4	1.2500	3	6	081089	1
1-5/16	1.3125	3	6	081090	1
1-3/8	1.3750	3	6	081091	1
1-7/16	1.4375	3	6	081092	1
1-1/2	1.5000	3	6	081093	1

DRILLS

• Aircraft Extension Drill

• Broca extralarga para la industria Aeronáutica

• Foret aéronautique à queue cylindrique rallongée



Point: 135° Split Point
 Material: High Speed Steel
 Coating/Finish: Black Oxide
 Other: 6" Aircraft Extension, Heavy-Duty Construction



Point: 135° Split Point
 Material: High Speed Steel
 Coating/Finish: Black Oxide
 Other: 12" Aircraft Extension, Heavy-Duty Construction

8256

Packaging: Tube

T6HH Size	Decimal Equivalent	Flute Length	Overall Length	Stock#	Pkg Qty
1/16	.0625	7/8	6	082503	6
5/64	.0781	1	6	082504	6
3/32	.0938	1-1/4	6	082505	6
7/64	.1094	1-1/2	6	082506	6
1/8	.1250	1-5/8	6	082507	6
9/64	.1406	1-3/4	6	082508	6
5/32	.1562	2	6	082509	6
11/64	.1719	2-1/8	6	082510	6
3/16	.1875	2-5/16	6	082511	6
13/64	.2031	2-7/16	6	082512	6
7/32	.2188	2-1/2	6	082513	6
15/64	.2344	2-5/8	6	082514	6
1/4	.2500	2-3/4	6	082515	6
17/64	.2656	2-7/8	6	082516	6
9/32	.2812	2-15/16	6	082517	6
19/64	.2969	3-1/16	6	082518	6
5/16	.3125	3-3/16	6	082519	6
21/64	.3281	3-5/16	6	082520	6
11/32	.3438	3-7/16	6	082521	6
23/64	.3594	3-1/2	6	082522	6
3/8	.3750	3-5/8	6	082523	6
25/64	.3906	3-3/4	6	082524	6
13/32	.4062	3-7/8	6	082525	6
27/64	.4219	3-15/16	6	082526	6
7/16	.4375	4-1/16	6	082527	6
29/64	.4531	4-3/16	6	082528	6
15/32	.4688	4-5/16	6	082529	6
31/64	.4844	4-3/8	6	082530	6
1/2	.5000	4-1/2	6	082531	6

82512

Packaging: Tube

Size	Decimal Equivalent	Flute Length	Overall Length	Stock#	Pkg Qty
1/16	.0625	7/8	12	082550	6
5/64	.0781	1	12	082551	6
3/32	.0938	1-1/4	12	082552	6
7/64	.1094	1-1/2	12	082553	6
1/8	.1250	1-5/8	12	082554	6
9/64	.1406	1-3/4	12	082555	6
5/32	.1562	2	12	082556	6
11/64	.1719	2-1/8	12	082557	6
3/16	.1875	2-5/16	12	082558	6
13/64	.2031	2-7/16	12	082559	6
7/32	.2188	2-1/2	12	082560	6
15/64	.2344	2-5/8	12	082561	6
1/4	.2500	2-3/4	12	082562	6
17/64	.2656	2-7/8	12	082563	6
9/32	.2812	2-15/16	12	082564	6
19/64	.2969	3-1/16	12	082565	6
5/16	.3125	3-3/16	12	082566	3
21/64	.3281	3-5/16	12	082567	3
11/32	.3438	3-7/16	12	082568	3
23/64	.3594	3-1/2	12	082569	3
3/8	.3750	3-5/8	12	082570	3
25/64	.3906	3-3/4	12	082571	3
13/32	.4062	3-7/8	12	082572	3
27/64	.4219	3-15/16	12	082573	3
7/16	.4375	4-1/16	12	082574	3
29/64	.4531	4-3/16	12	082575	3
15/32	.4688	4-5/16	12	082576	3
31/64	.4844	4-3/8	12	082577	3
1/2	.5000	4-1/2	12	082578	3

• Body Drill

• Broca Hojalatero

• Foret Pour Carrosserie



Point: 135° Split Point, Double End
 Material: High Speed Steel
 Coating/Finish: Black Oxide
 Other: Recommended use in thin sheet metal. Popular for pop-rivet drilling applications

831 Packaging: Tube

Size	Decimal Equivalent	Flute Length	Overall Length	Stock#	Pkg Qty
7/64	.1094	1/2	1-7/8	083100	12
1/8	.1250	1/2	2	083101	12
9/64	.1406	1/2	2	083102	12
5/32	.1562	1/2	2-1/16	083103	12
3/16	.1875	1/2	2-3/16	083105	12
7/32	.2188	1/2	2-3/8	083107	12
1/4	.2500	1/2	2-1/2	083109	12
30	.1285	1/2	2	083030	12



Black oxide finish provides added lubricity



How to Tap Effectively

Successful tapping includes selecting the proper tap for the application. Consideration must be given to:

- The material to be tapped
- The material hardness
- Whether the hole is a through hole or a blind hole
- The depth or length of thread
- The percentage of thread

Tapping Geometry

- **Straight Flute Taps** contain most of the chip in the flutes, and can be used for through or blind holes.
- **Spiral Point Taps** push the chips forward, and are recommended for through holes.
- **Taper Taps** are used for starting threads in tougher materials.
- **Bottoming Taps** are used for blind holes to obtain the maximum length of thread.
- **Plug Taps** are suitable for either through or blind holes, where ample clearance remains between the thread the the bottom of the hole.

Tap Set Section starting
on page 61



• Straight Flute Hand Tap

• Machos de mano

• Tarauds a main

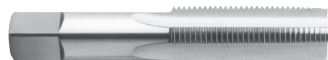

Material: Heat-Treated Carbon Steel
 Coating/Finish: Bright Finish
 Chamfer: Taper (7-10 threads long); Plug (3-5 threads long); Bottoming (1-2 threads long)
 Other: Not recommended for machine tapping

833T (Taper)

Packaging: Envelope

Size/ Pitch	Thread Designation	Thread Class	# of Flutes	Drill Size	Stock#	Pkg Qty
4-40	NC	2B	3	43	083333	5
5-40	NC	2B	3	38	083334	5
6-32	NC	2B	3	36	083335	5
8-32	NC	2B	3	29	083336	5
10-24	NC	2B	3	25	083337	5
10-32	NF	2B	3	21	083338	5
12-24	NC	2B	3	16	083339	5
1/4-20	NC	2B	3	7	083359	5
1/4-28	NF	2B	3	3	083360	5
5/16-18	NC	2B	4	F	083361	5
5/16-24	NF	2B	4	I	083362	5
3/8-16	NC	2B	4	5/16	083363	5
3/8-24	NF	2B	4	Q	083364	5
7/16-14	NC	2B	4	U	083365	5
7/16-20	NF	2B	4	25/64	083366	5
1/2-13	NC	2B	4	27/64	083367	5
1/2-20	NF	2B	4	29/64	083368	5
9/16-12	NC	2B	4	31/64	083369	1
9/16-18	NF	2B	4	33/64	083370	1
5/8-11	NC	2B	4	17/32	083371	1
5/8-18	NF	2B	4	37/64	083372	1
3/4-10	NC	2B	4	21/32	083373	1
3/4-16	NF	2B	4	11/16	083374	1
7/8-9	NC	2B	4	49/64	083375	1
1-8	NC	2B	4	7/8	083376	1

Packaging: 9/16-12 through 1-8 = 1 per box

833B (Bottoming)

Packaging: Envelope

Size/ Pitch	Thread Designation	Thread Class	# of Flutes	Drill Size	Stock#	Pkg Qty
1/4-20	NC	2B	3	7	083340	5
1/4-28	NF	2B	3	3	083341	5
5/16-18	NC	2B	4	F	083342	5
5/16-24	NF	2B	4	I	083343	5
3/8-16	NC	2B	4	5/16	083344	5
3/8-24	NF	2B	4	Q	083345	5
7/16-14	NC	2B	4	U	083346	5
7/16-20	NF	2B	4	25/64	083347	5
1/2-13	NC	2B	4	27/64	083348	5
1/2-20	NF	2B	4	29/64	083349	5
9/16-12	NC	2B	4	31/64	083350	1
9/16-18	NF	2B	4	33/64	083351	1
5/8-11	NC	2B	4	17/32	083352	1
5/8-18	NF	2B	4	37/64	083354	1
3/4-10	NC	2B	4	21/32	083355	1
3/4-16	NF	2B	4	11/16	083356	1
7/8-9	NC	2B	4	49/64	083357	1
1-8	NC	2B	4	7/8	083358	1

Packaging: 9/16-12 through 1-8 = 1 per box

833P (Plug)

Packaging: Envelope

Size/ Pitch	Thread Designation	Thread Class	# of Flutes	Drill Size	Stock#	Pkg Qty
2-56	NC	2B	3	50	083397	5
3-56	NF	2B	3	45	083398	5
4-40	NC	2B	3	43	083399	5
5-40	NC	2B	3	38	083400	5
5-44	NF	2B	3	37	083401	5
6-32	NC	2B	3	36	083402	5
8-32	NC	2B	3	29	083403	5
8-36	NF	2B	3	29	083404	5
10-24	NC	2B	3	25	083405	5
10-32	NF	2B	3	21	083406	5
12-24	NC	2B	3	16	083407	5
6-48	NS	2B	3	32	083408	5
8-40	NS	2B	3	28	083409	5
3/16-24	NS	2B	3	26	083377	5
3/16-32	NS	2B	3	22	083378	5
1/4-20	NC	2B	3	7	083379	5
1/4-28	NF	2B	3	3	083380	5
5/16-18	NC	2B	4	F	083381	5
5/16-24	NF	2B	4	I	083382	5
3/8-16	NC	2B	4	5/16	083383	5
3/8-24	NF	2B	4	Q	083384	5
7/16-14	NC	2B	4	U	083385	5
7/16-20	NF	2B	4	25/64	083386	5
1/2-13	NC	2B	4	27/64	083387	5
1/2-20	NF	2B	4	29/64	083388	5
9/16-12	NC	2B	4	31/64	083389	1
9/16-18	NF	2B	4	33/64	083390	1
5/8-11	NC	2B	4	17/32	083391	1
5/8-18	NF	2B	4	37/64	083392	1
3/4-10	NC	2B	4	21/32	083393	1
3/4-16	NF	2B	4	11/16	083394	1
7/8-9	NC	2B	4	49/64	083395	1
1-8	NC	2B	4	7/8	083396	1

Packaging: 9/16-12 through 1-8 = 1 per box

834P (Plug)

Packaging: Tube

Size/ Pitch	Thread Designation	Thread Class	# of Flutes	Drill Size	Stock#	Pkg Qty
1/4-20	NC	2B	3	7	083420	1
1/4-28	NF	2B	3	3	083421	1
5/16-18	NC	2B	4	F	083422	1
5/16-24	NF	2B	4	I	083423	1
3/8-16	NC	2B	4	5/16	083424	1
3/8-24	NF	2B	4	Q	083425	1
7/16-14	NC	2B	4	U	083426	1
7/16-20	NF	2B	4	25/64	083427	1
1/2-13	NC	2B	4	27/64	083428	1
1/2-20	NF	2B	4	29/64	083429	1
4-40	NC	2B	3	43	083430	1
6-32	NC	2B	3	36	083431	1
8-32	NC	2B	3	29	083432	1
10-24	NC	2B	3	25	083433	1

TAPS & DIES

NC = National Course NF = National Fine
 NS = National Special NPT = National Pipe Thread

• Straight Flute Hand Tap



Material: Heat-Treated Carbon Steel
 Coating/Finish: Bright Finish
 Chamfer: Taper (7-10 threads long); Plug (3-5 threads long); Bottoming (1-2 threads long)
 Other: Not recommended for machine tapping

• Machos de mano

• Tarauds a main

834MP (Metric Plug)

Packaging: Envelope

Size/ Pitch	Thread Class	# of Flutes	Drill Size	Stock#	Pkg Qty
M3 x 0.50	6H	3	#39	083410	5
M4 x 0.70	6H	3	3.3mm	083411	5
M5 x 0.80	6H	3	#19	083412	5
M6 x 1.00	6H	3	#8	083413	5
M8 x 1.25	6H	4	H	083414	5
M10 x 1.50	6H	4	Q	083415	5
M12 x 1.25	6H	4	27/64	083416	5
M12 x 1.75	6H	4	Y	083417	5

834MP (Metric Plug)

Packaging: Tube

Size/ Pitch	Thread Class	# of Flutes	Drill Size	Stock#	Pkg Qty
M4 x 0.70	6H	3	3.3mm	083436	1
M5 x 0.80	6H	3	#19	083437	1
M6 x 1.00	6H	3	#8	083438	1
M8 x 1.25	6H	4	H	083439	1
M10 x 1.25	6H	4	11/32	083440	1
M10 x 1.50	6H	4	Q	083441	1
M12 x 1.25	6H	4	27/64	083442	1
M12 x 1.75	6H	4	Y	083443	1
M14 x 1.50	6H	4	12.5mm	083444	1
M14 x 2.00	6H	4	12mm	083419	1



Straight flute taps can be used
in through or blind holes

• Taper Pipe Hand Tap

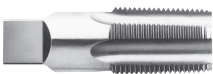

Material: Heat-Treated Carbon Steel
 Coating/Finish: Bright Finish
 Other: Not recommended for machine tapping

• Machos de mano

• Tarauds a main

834NPT

Packaging: Tube

Size/ Pitch	Thread Designation	Drill Size	# of Flutes	Stock#	Pkg Qty
1-11-1/2	NPT	1-5/32	5	083445	1
2-11-1/2	NPT	2-7/32	7	083446	1
1/2-14	NPT	45/64	4	083447	1
1/4-18	NPT	7/16	4	083448	1
1/8-27	NPT	R	4	083449	1
3/4-14	NPT	59/64	4	083450	1
3/8-18	NPT	37/64	4	083451	1
1-1/2-11-1/2	NPT	1-47/64	7	083452	1
1-1/4-11-1/2	NPT	1-1/2	5	083453	1



Look for this icon for more tap and
other helpful information

TAPS & DIES

NC = National Course NF = National Fine
 NS = National Special NPT = National Pipe Thread

• **Standard Hex Dies**

• **Terrajas, Exterior Hexagonal**

• **Filieres Hexagonales**

• **Hex Rethreading Dies**

• **Terrajas, Exterior Hexagonal**

• **Filieres Hexagonales**



Material: Carbon Steel
Coating/Finish: Bright Finish
Other: For use in ratchets or adjustable wrenches



Material: Carbon Steel, Heavy-Duty
Coating/Finish: Bright Finish
Other: Heavy-Duty dies are made the same size as matching nut, eliminating the need for more than one wrench

834H

Packaging: Tube

Size/ Pitch	Thread Designation	Across Flats	Stock#	Pkg Qty
6-32	NC	1	083474	5
8-32	NC	1	083475	5
10-24	NC	1	083476	5
10-32	NF	1	083477	5
12-24	NC	1	083478	5
14-20	NS	1	083479	5
1/4-20	NC	1	083480	5
1/4-28	NF	1	083481	5
5/16-18	NC	1	083482	5
5/16-24	NC	1	083483	5
3/8-16	NC	1	083484	5
3/8-24	NF	1	083485	5
7/16-14	NC	1	083486	5
7/16-20	NF	1	083487	5
1/2-13	NC	1	083488	5
1/2-20	NF	1	083490	5
1/8-27	NPT	1	083491	5
1/4-18	NPT	1	083492	5
9/16-18	NF	1-7/16	083493	1
5/8-11	NC	1-7/16	083494	1
5/8-18	NF	1-7/16	083495	1
3/4-10	NC	1-7/16	083496	1
3/4-16	NF	1-7/16	083497	1
1/8-27	NPT	1-7/16	083498	1
1/4-18	NPT	1-7/16	083499	1
3/8-18	NPT	1-7/16	083500	1
1/2-14	NPT	1-7/16	083501	1

835RD

Packaging: Tube

Size/ Pitch	Thread Designation	Across Flats	Stock#	Pkg Qty
1/4-20	NC	19/32	083528	5
1/4-28	NF	19/32	083529	5
5/16-18	NC	11/16	083530	5
5/16-24	NF	11/16	083531	5
3/8-16	NC	25/32	083532	5
3/8-24	NF	25/32	083533	5
7/16-14	NC	7/8	083534	5
7/16-20	NF	7/8	083535	5
1/2-13	NC	1-1/16	083536	5
1/2-20	NF	1-1/16	083537	5
9/16-12	NC	1-1/16	083538	5
9/16-18	NF	1-1/16	083539	5
5/8-11	NC	1-1/4	083540	1
5/8-18	NF	1-1/4	083541	1
11/16-11	NS	1-7/16	083542	1
11/16-16	NS	1-7/16	083543	1
3/4-10	NC	1-7/16	083544	1
3/4-16	NF	1-7/16	083545	1
7/8-9	NC	1-5/8	083546	1
7/8-14	NF	1-5/8	083547	1
1-8	NC	1-13/16	083548	1*
1-12	NF	1-13/16	083549	1*
1-14	NS	1-13/16	083550	1*
1-1/8-7	NC	2	083551	1*
1-1/8-12	NF	2	083552	1*
1-1/4-7	NC	2-3/16	083553	1*
1-1/4-12	NF	2-3/16	083554	1*
1-3/8-6	NC	2-3/8	083521	1*
1-3/8-12	NF	2-3/8	083522	1*
1-1/2-6	NC	2-9/16	083523	1*
1-1/2-12	NF	2-9/16	083524	1*
1/8-27	NPT	25/32	083525	5
1/4-18	NPT	1-1/16	083526	5
3/8-18	NPT	1-1/4	083527	1
1/2-14	NPT	1-7/16	083555	1
3/4-14	NPT	1-13/16	083556	1*
1-11-1/2	NPT	2-13/16	083557	1*

* = 1 per box

835H

Packaging: Tube

Size/ Pitch	Thread Designation	Across Flats	Stock#	Pkg Qty
6-32	NC	1	083502	1
8-32	NC	1	083503	1
10-24	NC	1	083504	1
10-32	NF	1	083505	1
12-24	NC	1	083506	1
14-20	NS	1	083507	1
1/4-20	NC	1	083508	1
1/4-28	NF	1	083509	1
5/16-18	NC	1	083510	1
5/16-24	NF	1	083511	1
3/8-16	NC	1	083512	1
3/8-24	NF	1	083513	1
7/16-14	NC	1	083514	1
7/16-20	NF	1	083515	1
1/2-13	NC	1	083516	1
1/2-20	NF	1	083518	1
1/8-27	NPT	1	083519	1
1/4-18	NPT	1	083520	1

• **Die Stock** • **Maneta para Terrajas "Portaterrajas"** • **Porte fileres**



Packaging: Tube

Series	Size	Stock#	Pkg Qty
835DS	1" O.D. Round	083569	1
835DS	1" O.D. Hex	083570	1

NC = National Course NF = National Fine
NS = National Special NPT = National Pipe Thread

Tap Wrenches

Packaging: Tube



T-Handle

Straight Handle

Style	Handle	Capacity	Stock#	Pkg Qty
T-Handle				
834THW	Tap Wrench	0 to 1/4	083559	1
834THW	Tap Wrench	12 to 5/16	083560	1
834THW	Tap Wrench	1/4 to 1/2	083561	1
Straight Handle				
834SHW	Tap Wrench	0 to 3/16	083558	1
834SHW	Tap Wrench	10 to 1/2	083562	1
834SHW	Tap Wrench (Wrapped)	3/8 to 1"	083563	1



Point: Screw Extractor
 Material: Carbon Steel
 Coating/Finish: Gray Finish
 Other: Use for removing threaded pipe sections

841

Packaging: Tube

Screw Ext#	For Removing Screw Size	Use Drill Size	Stock#	Pkg Qty
1	3/32 to 5/32	1/16 to 5/64	084101	12
2	5/32 to 7/32	3/32 to 7/64	084102	12
3	7/32 to 9/32	9/64 to 5/32	084103	12
4	9/32 to 3/8	7/32 to 1/4	084104	6
5	3/8 to 5/8, 1/8, 1/4 pipe	17/64 to 19/64	084105	6
6	5/8 to 7/8, 3/8 pipe	25/64 to 27/64	084106	1
7	7/8 to 1-1/8, 1/2 pipe	33/64 to 35/64	084107	1
8	1-1/8 to 1-3/8, 3/4 pipe	25/32 to 27/32	084108	1
9	1-3/8 and up, 1" pipe	1-1/16 to 1-1/8	084109	1

841, Spiral Flute

Packaging: Tube

Screw Ext#	For Removing Screw Size	Use Drill Size	Stock#	Pkg Qty
1	3/32 to 5/32	1/16 to 5/64	084110	1
2	5/32 to 7/32	3/32 to 7/64	084111	1
3	7/32 to 9/32	9/64 to 5/32	084112	1
4	9/32 to 3/8	7/32 to 1/4	084113	1
5	3/8 to 5/8, 1/8 & 1/4 pipe	17/64 to 19/64	084114	1



Point: Flat Woodboring Bit, Spade Point
 Material: Carbon Steel
 Coating/Finish: Gray Finish
 Other: 3-flats or quick-hex. Recommended use: hardwood, formica, particle board

840

Packaging: Tube

Size	Decimal Equivalent	Overall Length	Stock#	Pkg Qty
5/16	.3125	6	084001	1
3/8	.3750	6	084002	1
7/16	.4375	6	084003	1
1/2	.5000	6	084004	1
9/16	.5625	6	084005	1
5/8	.6250	6	084006	1
11/16	.6875	6	084007	1
3/4	.7500	6	084008	1
13/16	.8125	6	084009	1
7/8	.8750	6	084010	1
15/16	.9375	6	084011	1
1"	1.0000	6	084012	1
1-1/8	1.1250	6	084013	1
1-1/4	1.2500	6	084014	1
1-3/8	1.3750	6	084015	1
1-1/2	1.5000	6	084016	1



Point: Masonry Drill, Standard Length, 118° Point
 Material: Carbide-Tipped
 Coating/Finish: Zinc Coated/Sandblasted Finish/Black Finish
 Other: Recommended use in hard concrete aggregates

850, 855

Packaging: Tube

Size	Minimum Diameter Equiv.	Shank Dia.	Overall Length	850 Regular Helix Stock#	855 High Helix Stock#	Pkg Qty
1/8	.134	1/8	3	085001	085501	1
5/32	.165	5/32	3	085002		1
3/16	.198	3/16	4	085003	085503	1
3/16	.198	3/16	6	085004		1
1/4	.260	1/4	4	085005	085505	1
1/4	.260	1/4	6	085006	085506	1
1/4	.260	1/4	12	085007		1
1/4	.260	1/4	18	085008		1
1/4	.260	1/4	24	085009		1
5/16	.327	1/4	4	085010	085510	1
5/16	.327	1/4	6	085011	085511	1
5/16	.327	1/4	12	085012		1
5/16	.327	1/4	24	085013		1
3/8	.390	1/4	4	085014	085514	1
3/8	.390	1/4	6	085015	085515	1
3/8	.390	1/4	12	085016		1
3/8	.390	1/4	18	085017		1
3/8	.390	1/4	24	085018		1
1/2	.525	3/8	6	085019	085519	1
1/2	.525	3/8	12	085020		1
1/2	.525	3/8	18	085021		1
1/2	.525	3/8	24	085022		1



Point: Glass & Tile Drill
 Material: Carbide-Tipped Point
 Coating/Finish: Gray Finish
 Other: For use in glass, tile, mirrors, and ceramics

860

Packaging: Tube

Size	Minimum Diameter Equivalent	Shank Dia.	Overall Length	Stock#	Pkg Qty
1/8	.134	.107	2-1/8	086001	1
3/16	.198	.155	2-1/4	086002	1
1/4	.260	.175	2-9/16	086003	1
5/16	.327	.215	3	086004	1
3/8	.390	.235	3-1/2	086005	1
1/2	.525	.312	3-1/2	086006	1

SPECIAL PURPOSE

DRILL SETS

Jobber (Metal Index).....	66
Reduced Shank, (Molded Case).....	66
Round Plastic Twist Top	66



TAP/DIE SETS

Plastic/Molded Cases.....	66-67
---------------------------	-------



SPECIAL PURPOSE SETS (Plastic Cases)

Flat Woodboring Sets	66
Screw Extractor Sets.....	66



SETS - DRILLS (Metal Index)

DRILL SET - Series 801-29 - 29 Piece, Jobber Length, General Purpose, Fractional, Black Oxide, Import

1/16"-1/2" by 64ths 089001

DRILL SET - Series 805-29 - 29 Piece, Jobber Length, General Purpose, Fractional, Cobalt, Import

1/16"-1/2" by 64ths 089200

DRILL SET - Series 807-29 - 29 Piece, Jobber Length, Heavy-Duty, Fractional, Black/Bronze Oxide, Import

1/16"-1/2" by 64ths 089300

DRILL SET - Series 801-13 - 13 Piece, Jobber Length, General Purpose, Fractional, Black Oxide, Import

1/16"-1/4" by 64ths 089100

DRILL SET - Series 805-13 - 13 Piece, Jobber Length, General Purpose, Fractional, Cobalt, Import

1/16"-1/4" by 64ths 089101

DRILL SET - Series 807-13 - 13 Piece, Jobber Length, Heavy-Duty, Fractional, Black/Bronze Oxide, Import

1/16"-1/4" by 64ths 089102

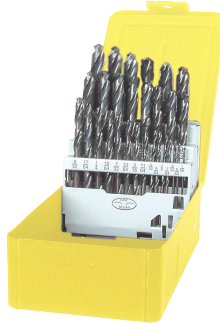

SETS - DRILLS (Molded Case)

DRILL SET - Series 810-8 - 8 Piece, S&D, 1/2" Reduced Shank, 3-Flat, 135° Split Point, Black/Bronze Oxide, Import

9/16"-1" by 16ths 084153



SETS - DRILLS (Round Plastic Twist Top)

DRILL SET - Series 801-29BB - 29 Piece, General Purpose, Import

1/16"-1/2" by 64ths 089002

DRILL SET - Series 805-29BB - 29 Piece, Heavy-Duty, Cobalt Import

1/16"-1/2" by 64ths 089201



DRILL SET - Series 807-29BB - 29 Piece, Heavy-Duty, Black & Gold, Import

1/16"-1/2" by 64ths 089301

SETS - TAPS & DIES (Plastic Case)

TAP SET - Series 836 - 10 Piece, Fractional, Plug, Import

1/4-20 NC, 1/4-28 NF, 5/16-18 NC 083566
5/16-24 NF, 3/8-16 NC, 3/8-24 NF,
7/16-14 NC, 7/16-20 NF, 1/2-13 NC, 1/2-20 NF



TAP/DRILL SET - Series 836 - 10 Piece, 5 Taps, 5 Drills, Carbon Steel, Import

Taps: 083568
6-32 NC, 8-32 NC, 10-24 NC,
10-32 NF, 1/4-20 NC

Drills: 36, 29, 25, 21, 7



TAP SET - Series 834SET - Carbon Steel Taps, 3-piece set, one each: Taper, Plug, Bottoming

3/16-24 NS	083454
3/16-32 NS	083455
1/4-20 NC	083456
1/4-28 NF	083457
5/16-18 NC	083458
5/16-24 NF	083459
3/8-16 NC	083460
3/8-24 NF	083461
7/16-14 NC	083462
7/16-20 NF	083463
1/2-13 NC	083464
1/2-20 NF	083465
9/16-12 NC	083466
9/16-18 NF	083467
5/8-11 NC	083468
5/8-18 NF	083469
3/4-10 NC	083470
3/4-16 NF	083471
7/8-9 NC	083472
1-8 NC	083473



FLAT WOODBORING SET - Series 840 6 Piece, Import, in Plastic Case

3/8, 1/2, 5/8, 3/4 084050



SCREW EXTRACTOR SETS - Series 841 in Plastic Case

#1-#6 084151
#2-#5 084150
10 pc Drill/Extractor 084152



NC - National Course; NF - National Fine
NPT - National Pipe Thread; NS - National Special

SETS - TAPS & DIES (Plastic/Molded Case)

TAP SET - Series 836 - 19 Piece, Plug, Screw Machine Length, Import

080 NF, 1-72 NF, 2-64 NF, 3-56 NF, 083567
 , 4-48 NF, 5-44 NF, 6-40 NF, 8-36 NF,
 10-32 NF, 12-28, NF1-64 NC, 2-56 NC,
 3-48 NC, 4-40 NC, 5-40 NC, 6-32 NC,
 8-32 NC, 10-24 NC, 12-24 NC



TAP & DIE SET - Series 836 - 1" O.D., 24 Piece, 10 Plug Taps, 10 Hex Dies, General Purpose, Bright Finish, Import

1/4-20 NC, 5/16-18 NC, 3/8-16 NC, 083565
 7/16-14 NC, 1/2-13 NC, 1/4-28 NF
 5/16-24 NF, 3/8-24 NF, 7/16-20 NF, 1/2-20 NF

Accessories Include:

- 1/8-27 NPT Hex Die
- 1/8-27 NPT Pipe Tap
- TRD50 Hex Die Stock
- JT40 Tap Wrench



TAP & DIE SET - Series 836 - 38 Piece, 17 Plug Taps, 16 Hex Dies, Combination Sizes, Bright Finish, Import

1/4-20 NC, 5/16-18 NC, 3/8-16 NC, 083571
 7/16-14 NC, 1/2-13 NC, 4-40 NC,
 6-32 NC, 8-32 NC, 10-24 NC, 12-24 NC,
 1/4-28 NF, 5/16-24 NF, 3/8-24 NF,
 7/16-20 NF, 1/2-20 NF, 10-32 NF, 4-36 NS

Accessories Include:

- 1/8-27 NPT Round Dies
- 1/8-27 NPT Pipe Tap
- JT40 Tap Wrench
- JT20 Tap Wrench
- TRD47 Round Die Stock



SETS - TAPS & DIES (Molded Case)

TAP & DIE SET - Series 836 - 38 Piece, 17 Plug Taps, 16 Hex Dies, Combination Sizes, Bright Finish, Import

1/4-20 NC, 5/16-18 NC, 083572
 3/8-16 NC, 7/16-14 NC, 1/2-13 NC,
 4-40 NC, 6-32 NC, 8-32 NC, 10-24 NC,
 12-24 NC, 1/4-28 NF, 5/16-24 NF, 3/8-24 NF,
 7/16-20 NF, 1/2-20 NF, 10-32 NF, 4-36 NS

Accessories Include:

- 1/8-27 NPT Hex Die
- 1/8-27 NPT Pipe Tap
- JT40 Tap Wrench
- JT20 Tap Wrench
- TRD50 Hex Die Stock



TAP & DIE SET - Series 836 - 38 Piece, 17 Plug Taps, 17 Hex Dies, General Purpose, Bright Finish, Import

3mm x 0.60, 4mm x 0.70, 083573
 4mm x 0.75, 5mm x 0.80, 5mm x 0.90,
 6mm x 1.00, 7mm x 1.00, 8mm x 1.00,
 8mm x 1.25, 9mm x 1.00, 9mm x 1.25,
 10mm x 1.25, 10mm x 1.50, 11mm x 1.50,
 12mm x 1.25, 12mm x 1.50, 12mm x 1.75

Accessories Include:

- 1/8-27 NPT Pipe Tap
- JT40 Tap Wrench
- JT20 Tap Wrench
- TRD50 Hex Die Stock



TAP & DIE SET - Series 836 - 64 Piece, 26 Plug Taps, 26 Adj. Round Dies, (1", 1-1/2", 2" O.D.), Bright Finish, Import

1/4-20 NC, 5/16-18 NC, 083574
 3/8-16 NC, 7/16-14 NC, 1/2-13 NC,
 9/16-12 NC, 5/8-11 NC, 7/8-9 NC,
 3/4-10 NC, 1-8 NC, 4-40 NC, 6-32 NC,
 8-32 NC, 10-24 NC, 12-24 NC, 1/4-28 NF,
 5/16-24 NF, 3/8-24 NF, 7/16-20 NF,
 1/2-20 NF, 9/16-18 NF, 5/8-18 NF, 3/4-16 NF,
 7/8-14 NF, 10-32 NF, 1-14 NS

Accessories Include:

- 1/8-27, 1/4-18 NPT Pipe Taps and Dies
- Three round die stocks (1", 1-1/2", 2" O.D.)
- T-Handle tap wrench (#0-1/4)
- Two adjustable tap wrenches (1/16-1/2" and 1/4"-1-1/8")
- Screw pitch gauge and screw driver





Cutting Tool Information



DRILLING

- Common Drilling Terms 67
- Drill Reconditioning..... 66
- Point Characteristics..... 66
- Drilling - Cutting Speeds Table 68
- Decimal Equivalent Charts 69

TAPPING

- Common Tapping Terms 71
- How to Tap Effectively 73
- Tap/Drill Selector 72
- Tap Speeds Selector 73

Deep Hole Drilling

- When the hole depth is greater than three times the diameter, consider it a deep hole
- Step drilling, also called “peck”drilling, is the practice of drilling a short distance, then withdrawing the drill. This is often required to remove chips when drilling deep holes
- “Peck”drill just enough to prevent packing chips in the flutes
- Chip congestion (eg: chips clogging the flutes) is a major cause of drill failure

General Drilling Considerations

- Stability is important. Instability can cause drill breakage of poor hole quality, including irregular or oversized holes
- To prevent work hardening, pay attention to speeds and feeds. Feed pressure should be constant. Do not “peck”until half-way through a deep hole. Use moderate speeds and a variable drill motor if possible.
- To prevent lock-up (grabbing of drill by material or workpiece at breakthrough), ease through the material by reducing speed and feed.

Drill Point Characteristics

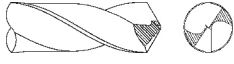
Type	Performance Benefits*	Comments
 Conventional Point (118°)	<ul style="list-style-type: none"> • General purpose • Widely available • Acceptable drill life • Best suited in mild steel and aluminum 	<ul style="list-style-type: none"> • Not self-centering; “walking” can occur on hard surfaces • May produce burrs on breakthrough
 Split Point (118° and 135°)	<ul style="list-style-type: none"> • Self centering • Excellent for portable drilling • Longer drill life • Good for drilling on curved surfaces • Improved penetration rates • Requires less effort • Breaks up chips • Best suited in alloy steels 	<ul style="list-style-type: none"> • Difficult to regrind

*Depends on application

Common Drilling Terms

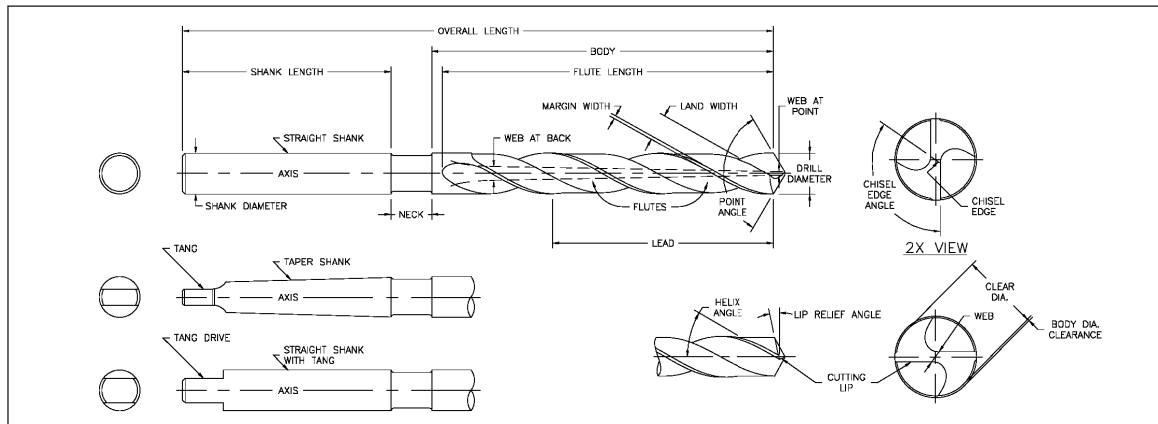

Axis

The imaginary straight line which forms the lengthwise center of a drill

Body

The section of a drill from the shank to the outer edges of the cutting lips

Body Clearance Diameter

The portion of the land that has been cut away so it will not bind against the walls of the hole

Chip Removal

The ability of a drill to pull material that has been cut away from the point, up the flutes and out of the hole

Chisel Edge

The edge at the end of the web that connects the cutting lips

Chisel Edge Angle

The angle between the chisel edge and cutting lip, as viewed from the end of a drill

Cobalt Steel

A heat-resistant steel that produces increased drill life

Drill Diameter

The diameter over the margins of a drill, measured at the point (Dia.)

Feeds

Feed rates for drilling are determined by the drill diameter, machinability of materials and depth of the desired hole. Small drills, harder materials and deeper holes require additional considerations in selecting proper feed rates

Flute

Groove cut in the body of drills to provide cutting surfaces, permit removal of chips and allow cutting fluid to reach cutting surfaces

Flute Length

The distance from the outer edges of the cutting lips to the extreme back of the flutes

Helix Angle

The angle formed between the leading edge of the land and the axis of a drill

High Speed Steel

The high quality steel used in drills for most maintenance and industrial applications

IPM

Feed rate in Inches Per Minute = IPR X RPM

IPR

Inches Per Revolution (Feed)

Land

The outer portion of the body between two adjacent flutes

Land Width

The distance between the leading edge and heel of the land, measured at a right angle to the leading edge

Lip Relief Angle

The relief angle at the outer corner of the lip

Lip

The cutting edge of a two-flute drill which extends from the chisel edge to the outer edge

Margin

The narrow raised surface on a drill body along the flute that stabilizes the drill in the hole

Neck

The section of reduced diameter between the body and the shank of a drill

Overall Length

The length from the end of the shank to the outer corners of the cutting lip

Point

The cone-shaped cutting end of a drill, made from the ends of the lands and the web

Point Angle

The angle of the cutting surfaces on a drill point, commonly 118° or 135°

RPM

Revolutions Per Minute = $\frac{SFM}{Dia.} \times 3.82$

SFM

Surface Feet Per Minute = RPM X Dia. X .26

Shank

The part of a drill by which it is held and driven

Size

Measurement reference for diameter size of a drill, expressed as either fractional, wire, letter or metric

Speed

The speed of a drill is determined by the rate which the outer edge of the tool rotates in relation to the material being cut. In general, the SFM is within a range based upon the workpiece material, its condition, hardness and depth of the hole. The deeper the hole, the greater tendency for more heat to be generated. Speed reduction is often recommended to minimize the amount of heat. It is usually best to start drilling at a slower speed and then increase.

Split Point

A special point configuration that eliminates "walking" so holes stay on center

Web

The central portion of the body that joins the lands. The extreme end of the web forms the chisel edge of a two-flute drill

Web Thickness

The thickness of the web at the point, unless otherwise specified



Drill Surface Treatments

Black Oxide

Black oxide is the most basic surface treatment recommended for drilling in iron and steel. It is not recommended for drilling in aluminum, magnesium or similar materials.

Drilling with a black oxide treated drill provides:

- Increased tempering and stress relieving
- Reduced galling and chip welding
- Increased retention of lubricants

TiN Coating

Titanium Nitride (TiN) performance coating can increase tool life and productivity by allowing higher speeds and heavier feeds. It is an excellent general purpose coating for protecting tools from wear. TiN coating is an excellent choice for drilling in iron and steel. It is also recommended for drilling in aluminum, magnesium or similar materials.

Drilling with a TiN coated drill provides:

- Increased surface hardness
- Reduced coefficient of friction
- Increased corrosion resistance
- A thermal barrier
- Additional tempering and stress relieving

Diameter Size	Surface Feet per Minute														
	10'	12'	15'	20'	25'	30'	35'	40'	45'	50'	60'	70'	80'	90'	100'
1/64	2445	2934	3667	4889	6112	7334	8556	9778	11001	12223	14668	17112	19557	22001	24446
1/32	1222	1467	1833	2445	3056	3667	4278	4889	5500	6112	7334	8556	9778	11001	12223
3/64	815	978	1222	1630	2037	2445	2852	3259	3667	4074	4889	5704	6519	7334	8149
1/16	611	733	917	1222	1528	1833	2139	2445	2750	3056	3667	4278	4889	5500	6112
5/64	489	587	733	978	1222	1467	1711	1956	2200	2445	2934	3422	3911	4400	4889
3/32	407	489	611	815	1019	1222	1426	1630	1833	2037	2445	2852	3259	3667	4074
7/64	349	419	524	698	873	1048	1222	1397	1572	1746	2095	2445	2794	3143	3492
1/8	306	367	458	611	764	917	1070	1222	1375	1528	1833	2139	2445	2750	3056
9/64	272	326	407	543	679	815	951	1086	1222	1358	1630	1901	2173	2445	2716
5/32	244	293	367	489	611	733	856	978	1100	1222	1467	1711	1956	2200	2445
11/64	222	267	333	444	556	667	778	889	1000	1111	1333	1556	1778	2000	2222
3/16	204	244	306	407	509	611	713	815	917	1019	1222	1426	1630	1833	2037
13/64	188	226	282	376	470	564	658	752	846	940	1128	1316	1504	1692	1880
7/32	175	210	262	349	437	524	611	698	786	873	1048	1222	1397	1572	1746
15/64	163	196	244	326	407	489	570	652	733	815	978	1141	1304	1467	1630
1/4	153	183	229	306	382	458	535	611	688	764	917	1070	1222	1375	1528
9/32	136	163	204	272	340	407	475	543	611	679	815	951	1086	1222	1358
5/16	122	147	183	244	306	367	428	489	550	611	733	856	978	1100	1222
11/32	111	133	167	222	278	333	389	444	500	556	667	778	889	1000	1111
3/8	102	122	153	204	255	306	357	407	458	509	611	713	815	917	1019
13/32	94	113	141	188	235	282	329	376	423	470	564	658	752	846	940
7/16	87	105	131	175	218	262	306	349	393	437	524	611	698	786	873
15/32	81	98	122	163	204	244	285	326	367	407	489	570	652	733	815
1/2	76	92	115	153	191	229	267	306	344	382	458	535	611	688	764
9/16	68	81	102	136	170	204	238	272	306	340	407	475	543	611	679
5/8	61	73	92	122	153	183	214	244	275	306	367	428	489	550	611
11/16	56	67	83	111	139	167	194	222	250	278	333	389	444	500	556
3/4	51	61	76	102	127	153	178	204	229	255	306	357	407	458	509
13/16	47	56	71	94	118	141	165	188	212	235	282	329	376	423	470
7/8	44	52	65	87	109	131	153	175	196	218	262	306	349	393	437
15/16	41	49	61	81	102	122	143	163	183	204	244	285	326	367	407
1	38	46	57	76	95	115	134	153	172	191	229	267	306	344	382
1-1/8	34	41	51	68	85	102	119	136	153	170	204	238	272	306	340
1-1/4	31	37	46	61	76	92	107	122	138	153	183	214	244	275	306
1-3/8	28	33	42	56	69	83	97	111	125	139	167	194	222	250	278
1-1/2	25	31	38	51	64	76	89	102	115	127	153	178	204	229	255

Material	SFM	Material	SFM
Aluminum and its Alloys	200-300	Steel (Continued)	
Brass and Bronze (Ordinary)	150-300	Steel (.4 carbon to .5 carbon)	70-80
Bronze (High Tensile)	70-150	Tool (1.2 carbon)	50-60
Die Castings (Zinc Base)	300-400	Forgings	40-50
Iron		Alloy—300 to 400 Brinell	20-30
Cast (Soft)	100-150	High Tensile (Heat Treated)	
Cast (Medium hard)	70-100	35 to 40 Rockwell C	30-40
Hard Chilled	30-40	40 to 45 Rockwell C	25-35
Malleable	80-90	45 to 50 Rockwell C	15-25
Magnesium and its Alloys	250-400	50 to 55 Rockwell C	7-15
Monel Metal or High-Nickel Steel	30-50	Stainless Steel	
Plastics or Similar Materials (Bakelite)	100-300	Free Machining Grades	30-80
Steel		Work Hardening Grades	15-50
Mild (.2 carbon to .3 carbon)	80-110	Wood	300-400

Drill Dia. Range	Light	Medium	Heavy
1/16 to 1/8"	.0005-.0010	.0010-.0020	.0020-.0040
1/8 to 1/4"	.0010-.0030	.0030-.0050	.0040-.0060
1/4 to 3/8"	.0030-.0050	.0050-.0070	.0060-.0100
3/8 to 1/2"	.0040-.0060	.0050-.0080	.0080-.0120
1/2 to 3/4"	.0050-.0070	.0070-.0100	.0090-.0140
3/4 to 1"	.0070-.0100	.0090-.0140	.0140-.0200



Drilling - Decimal Equivalent Chart (1 of 2)

Size	Decimal Equivalent	Size	Decimal Equivalent	Size	Decimal Equivalent	Size	Decimal Equivalent
97	.0059	61	.0390	37	.1040	4.90 mm	.1929
96	.0063	1.00 mm	.0394	2.70 mm	.1063	10	.1935
95	.0067	60	.0400	36	.1065	9	.1960
94	.0071	59	.0410	2.75 mm	.1083	5.00 mm	.1969
93	.0075	1.05 mm	.0413	7/64"	.1094	8	.1990
92	.0079	58	.0420	35	.1100	5.10 mm	.2008
91	.0083	57	.0430	2.80 mm	.1102	7	.2010
90	.0087	1.10 mm	.0433	34	.1110	13/64"	.2031
89	.0091	1.15 mm	.0453	33	.1130	6	.2040
88	.0095	56	.0465	2.90 mm	.1142	5.20 mm	.2047
.25 mm	.0098	3/64"	.0469	32	.1160	5	.2055
87	.0100	1.20 mm	.0472	3.00 mm	.1181	5.25 mm	.2067
86	.0105	1.25 mm	.0492	31	.1200	5.30 mm	.2087
85	.0110	1.30 mm	.0512	3.10 mm	.1220	4	.2090
84	.0115	55	.0520	1/8"	.1250	5.40 mm	.2126
.30 mm	.0118	1.35 mm	.0531	3.20 mm	.1260	3	.2130
83	.0120	54	.0550	3.25 mm	.1280	5.50 mm	.2165
82	.0125	1.40 mm	.0551	30	.1285	7/32"	.2188
.32 mm	.0126	1.45 mm	.0571	3.30 mm	.1299	5.60 mm	.2205
81	.0130	1.50 mm	.0591	3.40 mm	.1339	2	.2210
80	.0135	53	.0595	29	.1360	5.70 mm	.2244
.35 mm	.0138	1.55 mm	.0610	3.50 mm	.1378	5.75 mm	.2264
.36 mm	.0142	1/16"	.0625	28	.1405	1	.2280
79	.0145	1.60 mm	.0630	9/64"	.1406	5.80 mm	.2283
.38 mm	.0150	52	.0635	3.60 mm	.1417	5.90 mm	.2323
1/64"	.0156	1.65 mm	.0650	27	.1440	A	.2340
.40 mm	.0157	1.70 mm	.0669	3.70 mm	.1457	15/64"	.2344
78	.0160	51	.0670	26	.1470	6.00 mm	.2362
.42 mm	.0165	1.75 mm	.0689	3.75 mm	.1476	B	.2380
.44 mm	.0173	50	.0700	25	.1495	6.10 mm	.2402
.45 mm	.0177	1.80 mm	.0709	3.80 mm	.1496	C	.2420
77	.0180	1.85 mm	.0728	24	.1520	6.20 mm	.2441
.46 mm	.0181	49	.0730	3.90 mm	.1535	D	.2460
.48 mm	.0189	1.90 mm	.0748	23	.1540	6.25 mm	.2461
.50 mm	.0197	48	.0760	5/32"	.1562	6.30 mm	.2480
76	.0200	1.95 mm	.0768	22	.1570	1/4" E	.2500
75	.0210	5/64"	.0781	4.00 mm	.1575	6.40 mm	.2520
.55 mm	.0217	47	.0785	21	.1590	6.50 mm	.2559
74	.0225	2.00 mm	.0787	20	.1610	F	.2570
.60 mm	.0236	2.05 mm	.0807	4.10 mm	.1614	6.60 mm	.2598
73	.0240	46	.0810	4.20 mm	.1654	G	.2610
72	.0250	45	.0820	19	.1660	6.70 mm	.2638
.65 mm	.0256	2.10 mm	.0827	4.25 mm	.1673	17/64"	.2656
71	.0260	2.15 mm	.0846	4.30 mm	.1693	6.75 mm	.2657
.70 mm	.0276	44	.0860	18	.1695	H	.2660
70	.0280	2.20 mm	.0866	11/64"	.1719	6.80 mm	.2677
69	.0292	2.25 mm	.0886	17	.1730	6.90 mm	.2717
.75 mm	.0295	43	.0890	4.40 mm	.1732	I	.2720
68	.0310	2.30 mm	.0906	16	.1770	7.00 mm	.2756
1/32"	.0312	2.35 mm	.0925	4.50 mm	.1772	J	.2770
.80 mm	.0315	42	.0935	15	.1800	7.10 mm	.2795
67	.0320	3/32"	.0938	4.60 mm	.1811	K	.2810
66	.0330	2.40 mm	.0945	14	.1820	9/32"	.2812
.85 mm	.0335	41	.0960	13	.1850	7.20 mm	.2835
65	.0350	2.45 mm	.0965	4.70 mm	.1850	7.25 mm	.2854
.90 mm	.0354	40	.0980	4.75 mm	.1870	7.30 mm	.2874
64	.0360	2.50 mm	.0984	3/16"	.1875	L	.2900
63	.0370	39	.0995	4.80 mm	.1890	7.40 mm	.2913
.95 mm	.0374	38	.1015	12	.1890	M	.2950
62	.0380	2.60 mm	.1024	11	.1910	7.50 mm	.2953



Drilling - Decimal Equivalent Chart (2 of 2)

Size	Decimal Equivalent	Size	Decimal Equivalent	Size	Decimal Equivalent	Size	Decimal Equivalent
19/64"	.2969	12.50 mm	.4921	1-1/64"	1.0156	39.00 mm	1.5354
7.60 mm	.2992	1/2"	.5000	26.00 mm	1.0236	1-35/64"	1.5469
N	.3020	13.00 mm	.5118	1-1/32"	1.0312	39.50 mm	1.5551
7.70 mm	.3031	33/64"	.5156	26.50 mm	1.0433	1-9/16"	1.5625
7.75 mm	.3051	17/32"	.5312	1-3/64"	1.0469	40.00 mm	1.5748
7.80 mm	.3071	13.50 mm	.5315	1-1/16"	1.0625	1-37/64"	1.5781
7.90 mm	.3110	35/64"	.5469	27.00 mm	1.0630	1-19/32"	1.5938
5/16"	.3125	14.00 mm	.5512	1-5/64"	1.0781	40.50 mm	1.5945
8.00 mm	.3150	9/16"	.5625	27.50 mm	1.0827	1-39/64"	1.6094
O	.3160	14.50 mm	.5709	1-3/32"	1.0938	41.00 mm	1.6142
8.10 mm	.3189	37/64"	.5781	28.00 mm	1.1024	1-5/8"	1.6250
8.20 mm	.3228	15.00 mm	.5906	1-7/64"	1.1094	41.50 mm	1.6339
P	.3230	19/32"	.5938	28.50 mm	1.1220	1-41/64"	1.6406
8.25 mm	.3248	39/64"	.6094	1-1/8"	1.1250	42.00 mm	1.6535
8.30 mm	.3268	15.50 mm	.6102	1-9/64"	1.1406	1-21/32"	1.6562
21/64"	.3281	5/8"	.6250	29.00 mm	1.1417	1-43/64"	1.6719
8.40 mm	.3307	16.00 mm	.6299	1-5/32"	1.1562	42.50 mm	1.6732
Q	.3320	41/64"	.6406	29.50 mm	1.1614	1-11/16"	1.6875
8.50 mm	.3346	16.50 mm	.6496	1-11/64"	1.1719	43.00 mm	1.6929
8.60 mm	.3386	21/32"	.6562	30.00 mm	1.1811	1-45/64"	1.7031
R	.3390	17.00 mm	.6693	1-3/16"	1.1875	43.50 mm	1.7126
8.70 mm	.3425	43/64"	.6719	30.50 mm	1.2008	1-23/32"	1.7188
11/32"	.3438	11/16"	.6875	1-13/64"	1.2031	44.00 mm	1.7323
8.75 mm	.3445	17.50 mm	.6890	1-7/32"	1.2188	1-47/64"	1.7344
8.80 mm	.3465	45/64"	.7031	31.00 mm	1.2205	1-3/4"	1.7500
S	.3480	18.00 mm	.7087	1-15/64"	1.2344	44.50 mm	1.7520
8.90 mm	.3504	23/32"	.7188	31.50 mm	1.2402	1-49/64"	1.7656
9.00 mm	.3543	18.50 mm	.7283	1-1/4"	1.2500	45.00 mm	1.7717
T	.3580	47/64"	.7344	32.00 mm	1.2598	1-25/32"	1.7812
9.10 mm	.3583	19.00 mm	.7480	1-17/64"	1.2656	45.50 mm	1.7913
23/64"	.3594	3/4"	.7500	32.50 mm	1.2795	1-51/64"	1.7969
9.20 mm	.3622	49/64"	.7656	1-9/32"	1.2812	46.00 mm	1.8110
9.25 mm	.3642	19.50 mm	.7677	1-19/64"	1.2969	1-13/16"	1.8125
9.30 mm	.3661	25/32"	.7812	33.00 mm	1.2992	1-53/64"	1.8281
U	.3680	20.00 mm	.7874	1-5/16"	1.3125	46.50 mm	1.8307
9.40 mm	.3701	51/64"	.7969	33.50 mm	1.3189	1-27/32"	1.8438
9.50 mm	.3740	20.50 mm	.8071	1-21/64"	1.3281	47.00 mm	1.8504
3/8"	.3750	13/16"	.8125	34.00 mm	1.3386	1-55/64"	1.8594
V	.3770	21.00 mm	.8268	1-11/32"	1.3438	47.50 mm	1.8701
9.60 mm	.3780	53/64"	.8281	34.50 mm	1.3583	1-7/8"	1.8750
9.70 mm	.3819	27/32"	.8438	1-23/64"	1.3594	48.00 mm	1.8898
9.75 mm	.3839	21.50 mm	.8465	1-3/8"	1.3750	1-57/64"	1.8906
9.80 mm	.3858	55/64"	.8594	35.00 mm	1.3780	1-29/32"	1.9062
W	.3860	22.00 mm	.8661	1-25/64"	1.3906	48.50 mm	1.9094
9.90 mm	.3898	7/8"	.8750	35.50 mm	1.3976	1-59/64"	1.9219
25/64"	.3906	22.50 mm	.8858	1-13/32"	1.4062	49.00 mm	1.9291
10.00 mm	.3937	57/64"	.8906	36.00 mm	1.4173	1-15/16"	1.9375
X	.3970	23.00 mm	.9055	1-27/64"	1.4219	49.50 mm	1.9488
Y	.4040	29/32"	.9062	36.50 mm	1.4370	1-61/64"	1.9531
13/32"	.4062	59/64"	.9219	1-7/16"	1.4375	50.00 mm	1.9685
Z	.4130	23.50 mm	.9252	1-29/64"	1.4531	1-31/32"	1.9688
10.50 mm	.4134	15/16"	.9375	37.00 mm	1.4567	1-63/64"	1.9844
27/64"	.4219	24.00 mm	.9449	1-15/32"	1.4688	50.50 mm	1.9882
11.00 mm	.4331	61/64"	.9531	37.50 mm	1.4764	2"	2.0000
7/16"	.4375	24.50 mm	.9646	1-31/64"	1.4844		
11.50 mm	.4528	31/32"	.9688	38.00 mm	1.4961		
29/64"	.4531	25.00 mm	.9843	1-1/2"	1.5000		
15/32"	.4688	63/64"	.9844	1-33/64"	1.5156		
12.00 mm	.4724	1"	1.0000	38.50 mm	1.5157		
31/64"	.4844	25.50 mm	1.0039	1-17/32"	1.5312		

Common Tapping Terms

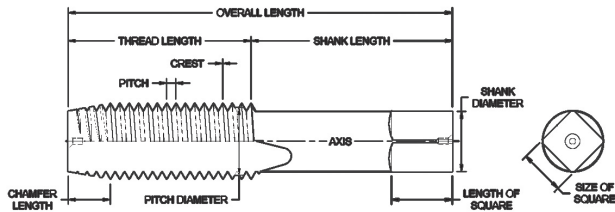

End Views

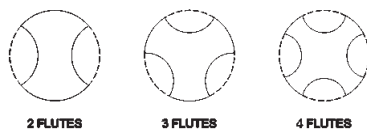

Chamfer Styles in Standard Taps

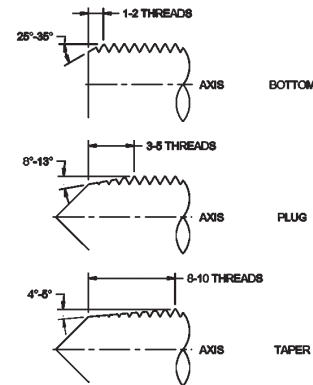

Angle of Thread

The angle included between the flanks of the thread measured in an axial plane

Back Taper

A slight axial relief on the thread of the tap which makes the pitch diameter of the thread near the shank somewhat smaller than that of the chamfered end

Bottoming Chamfer

The shortest chamfer (1-2 threads long) for threading close to the bottom of blind holes

Chamfer

The tapering of the threads at the front end of each land of a tap, by cutting away and relieving the crest of the first few teeth, to distribute the cutting action over several teeth

Chamfer Relief

The gradual decrease in land height from cutting edge to heel on the chamfered portion, to provide clearance for the cutting action as the tap advances

Chordal Hook Angle

The angle between the chord passing through the root and crest of a thread form at the cutting face, and a radial line through the crest at the cutting edge

Crest

The top surface joining the two flanks of a thread. The crest of an external thread is at its major diameter, while the crest of an internal thread is at its minor diameter

Cutting Face

The leading side of the land in the direction of rotation for cutting on which the chip impinges

Flutes

The longitudinal channels formed in a tap to create cutting edges on the thread profile, and to provide chip spaces and cutting fluid passages

Height of Thread

The distance between the crest and the base of a thread measured normal to the axis

Lead

The distance a screw thread advances axially in one complete turn. On a single lead screw or tap, the lead and pitch are identical. On a double-lead screw or tap, the lead is twice the pitch, etc.

Pitch

The distance from any point on a screw or tap thread to a corresponding point on the next thread, measured parallel to the axis. The pitch equals one divided by the number of threads per inch

Pitch Diameter

- On a straight thread, the diameter of any imaginary coaxial cylinder, the surface of which would pass through the thread profile at such points as to make equal the width of the threads and the width of the spaces cut by the surface of the cylinder

- On a taper thread, the diameter at a given distance from a reference plane perpendicular to the axis of an imaginary co-axial cone, the surface of which would pass through the thread profile at such points as to make equal the width of the threads and the width of the spaces cut by the surface of the cone

Plug Chamfer

The most common chamfer (3-5 threads long), for hand or machine tapping in through or blind holes

Rake

Any deviation of a straight cutting face of the tooth from a radial line.

Positive Rake means that the crest of the cutting face is angularly advanced ahead of the balance of the face of the tooth. **Negative Rake** means that the same point is angularly behind the balance of the cutting face of the tooth. **Zero Rake** means that the cutting face is directly on the center line

Spiral Point (Chip Driver)

A supplementary angular fluting cut in the cutting face of the land at the chamfer end. It is slightly longer than the chamfer on the tap, and of the opposite hand to that of rotation

Taper Chamfer

A long chamfer (8-10 threads long) for easier starting and engagement in the work piece. More working teeth means that less tapping torque is required, and the chip load is reduced on each tooth

Threads Per Inch

The number of threads in one inch of length



Tap Drill Selector (1 of 2)

Machine Screw/Fractional

Tap Size	Tap Drill Size	Decimal Equivalent of Tap Drill (Inches)	Theoretical Percent of Thread	Probable Percent of Thread
0-80	56	.0465	83	74
	3/64	.0469	81	71
	1.20 mm	.0472	79	69
	1.25 mm	.0492	67	57
1-64	54m	.0550	89	81
	1.45 mm	.0571	78	71
	53	.0595	67	59
1-72	1.50 mm	.0591	77	68
	53	.0595	75	67
	1.55 mm	.0610	67	68
2-56	51	.0670	82	74
	1.75 mm	.0689	73	66
	50	.0700	69	62
	1.80 mm	.0709	65	58
2-64	50	.0700	79	70
	1.80 mm	.0709	74	66
	49	.0730	64	56
3-48	48	.0760	85	78
	5/64	.0781	77	70
	47	.0785	76	69
	2.00 mm	.0787	75	68
	46	.0810	67	60
	45	.0820	63	56
3-56	46	.0810	78	69
	45	.0820	73	65
	2.10 mm	.0827	70	62
	2.15 mm	.0846	62	54
4-40	44	.0860	80	74
	2.20 mm	.0866	78	72
	43	.0890	71	65
	2.30 mm	.0906	66	60
4-48	2.35 mm	.0925	72	72
	42	.0935	68	61
	3/32	.0938	68	60
	2.40 mm	.0945	65	57
5-40	40	.0980	83	76
	39	.0995	79	71
	38	.1015	72	65
	2.60 mm	.1024	70	63
5-44	38	.1015	79	72
	2.60 mm	.1024	77	69
	37	.1040	71	63
6-32	37	.1040	84	78
	36	.1065	78	72
	7/64	.1095	70	64
	35	.1100	69	63
	34	.1110	67	60
6-40	34	.1110	83	75
	33	.1130	77	69
	2.90 mm	.1142	73	65
	32	.1160	68	60

Tap Size	Tap Drill Size	Decimal Equivalent of Tap Drill (Inches)	Theoretical Percent of Thread	Probable Percent of Thread
8-32	3.40 mm	.1339	74	67
	29	.1360	69	62
8-36	29	.1360	78	70
	3.50 mm	.1378	72	65
10-24	27	.1440	85	79
	3.70 mm	.1457	82	76
	26	.1470	79	74
	25	.1495	75	69
10-32	24	.1520	70	64
	5/32	.1563	83	75
	22	.1570	81	73
12-24	21	.1590	76	68
	11/64	.1719	82	75
	17	.1730	79	73
12-28	16	.1770	72	66
	15	.1800	84	77
	4.60 mm	.1811	78	70
1/4-20	14	.1820	75	67
	9	.1960	83	77
	8	.1990	79	73
1/4-28	7	.2010	75	70
	13/64	.2031	72	66
	5.40 mm	.2126	81	72
	3	.2130	80	72
5/16-18	F	.2570	77	72
	6.60 mm	.2598	73	68
	G	.2610	71	66
5/16-24	H	.2660	86	78
	6.80 mm	.2677	83	75
	I	.2720	75	67
3/8-16	J	.3071	84	78
	7.80 mm	.3110	79	73
	5/16	.3125	77	72
	O	.3160	73	68
3/8-24	21/64	.3281	87	79
	8.40 mm	.3307	82	74
	Q	.3320	79	71
	8.50 mm	.3346	75	67
7/16-14	R	.3580	86	81
	23/64	.3594	84	79
	9.20 mm	.3622	81	76
	9.30 mm	.3661	77	72
	U	.3680	75	70
7/16-20	V	.3701	73	68
	W	.3860	79	72
	25/64	.3906	72	65
1/2-13	10.50 mm	.4134	87	82
	27/64	.4219	78	73
1/2-20	29/64	.4531	72	65



Tap Drill Selector (2 of 2)

Machine Screw/Fractional (con't)

Tap Size	Tap Drill Size	Decimal Equivalent of Tap Drill (Inches)	Theoretical Percent of Thread	Probable Percent of Thread
9/16-12	15/32	.4688	87	82
	31/64	.4844	72	68
9/16-18	1/2	.5000	87	80
	17/32	.5313	79	75
	9/16	.5625	87	80
3/4-10	41/64	.6406	84	80
	21/32	.6563	72	68
3/4-16	11/16	.6875	77	71
	17.50 mm	.6890	75	69
7/8-9	49/64	.7656	76	72
	51/64	.7969	84	79
1"-8	55/64	.8594	87	83
	7/8	.8750	77	73
1"-12	29/32	.9063	87	81
	59/64	.9219	72	67
1"-14	59/64	.9219	84	78
	31/32	.9688	84	81
1-1/8-7	63/64	.9844	76	72
	1-1/8-12	1-1/32	1.0313	87
1-1/4-7	1-3/32	1.0938	84	*
	1-7/64	1.1094	76	*
1-1/4-12	1-11/64	1.1719	72	*
	1-3/8-6	1-13/64	1.2031	*
	1-7/32	1.2188	72	*
1-3/8-12	1-19/64	1.2969	72	*
	1-1/2-6	1-21/64	1.3281	*
	1-11/32	1.3438	72	*
1-1/2-12	1-27/64	1.4219	72	*

*Reaming recommended

Tapping Speeds

Proper tapping speeds are very important in obtaining efficient tapping results. The optimum speed for tapping is the highest speed that conditions permit, consistent with acceptable tool life. Speeds must be lowered as the length of the hole increases. In short holes, taps with tapered chamfers can be operated faster than taps with bottoming chamfers. Speeds can be increased when vertical tapping, as compared to horizontal tapping.

The chart below suggests a starting point for selecting the speed to operate the tap.

Tapping Speed Selector

Material	Speed (feet/min)	Material	Speed (feet/min)
Aluminum, Soft	90-110	Nuts, Cold Formed	60-80
Aluminum, Alloy	80-100	Plastics	60-80
Brass, Soft	90-110	Rubber, Hard	80-100
Brass, Hard	40-60	Screw Stock	65-90
Bronze, Soft	40-70	Steel, Alloy Grades	15-35
Bronze, Hard	30-50	Steel, Cast	20-35
Copper	50-60	Steel, Stainless	15-30
Die Castings	60-80	Steel, Tool Grades	25-40
Iron, Cast	70-100		

Metric

Tap Size	Tap Drill Size	Decimal Equivalent of Tap Drill (Inches)	Theoretical Percent of Thread	Probable Percent of Thread
M1.6 x 0.35	1.20 mm	.0472	88	80
	1.25 mm	.0492	77	69
M2 x 0.40	1/16	.0625	79	72
	1.60 mm	.0630	77	69
	52	.0635	74	66
M2.5 x 0.45	2.05 mm	.0807	77	69
	46	.0810	76	67
	45	.0820	71	63
M3 x 0.50	40	.0980	79	70
	2.50 mm	.0984	77	68
	39	.0995	73	64
M3.5 x 0.60	33	.1130	81	72
	2.90 mm	.1142	77	68
	32	.1160	71	63
M4 x 0.70	3.20 mm	.1260	88	80
	30	.1285	81	73
	3.30 mm	.1299	77	69
M4.5 x 0.75	3.70 mm	.1457	82	74
	26	.1470	79	70
	25	.1495	72	64
M5 x 0.80	4.20 mm	.1654	77	69
	19	.1660	75	68
M6 x 1.00	10	.1935	84	76
	9	.1960	79	71
	5.00 mm	.1968	77	70
	8	.1990	73	65
M7 x 1.00	A	.2340	81	74
	6.00 mm	.2362	77	70
	B	.2380	74	66
M8 x 1.25	6.70 mm	.2638	80	74
	17/64	.2656	77	71
	H	.2660	77	70
	6.80 mm	.2677	74	68
M10 x 1.50	8.40 mm	.3307	82	76
	Q	.3320	80	75
	8.50 mm	.3346	77	71
M12 x 1.75	10.25 mm	.4035	77	72
	Y	.4040	76	71
	13/32	.4062	74	69
M14 x 2.00	15/32	.4688	81	76
	12.00 mm	.4724	77	72
M16 x 2.00	35/64	.5469	81	76
	14.00 mm	.5512	77	72
M20 x 2.50	11/16	.6875	78	74
	17.50 mm	.6890	77	73
M24 x 3.00	13/16	.8125	86	82
	21.00 mm	.8268	76	73
	53/64	.8281	76	73
M30 x 3.50	1-1/32	1.0312	83	80
	26.50 mm	1.0433	77	73
	1-3/64	1.0469	75	70
M36 x 4.00	1-17/64	1.2656	74	



TRIUMPH TWIST DRILL

A Division of Minnesota Twist Drill

For over 50 years, Triumph Twist Drill has been manufacturing hundreds of thousands of drills a week...

At our 70,000 square foot facility located in Chisholm, MN, we incorporate cutting edge machinery and equipment to produce exceptional performance tools.

To find local support, contact Customer Service at 800/942/1501, or customerservicettd@mntwist.com. They are available weekdays 7:00 am through 5:00 pm CST.

CORPORATE HEADQUARTERS:

Triumph Twist Drill
1 Southwest 7th Street
Chisholm, MN 55719
800/942/1501
218/263/3891
Fax: 218/263/3887